

LIDO

INGROUND OR
INDECK POOLS
OVAL POOL
INSTRUCTION
MANUAL

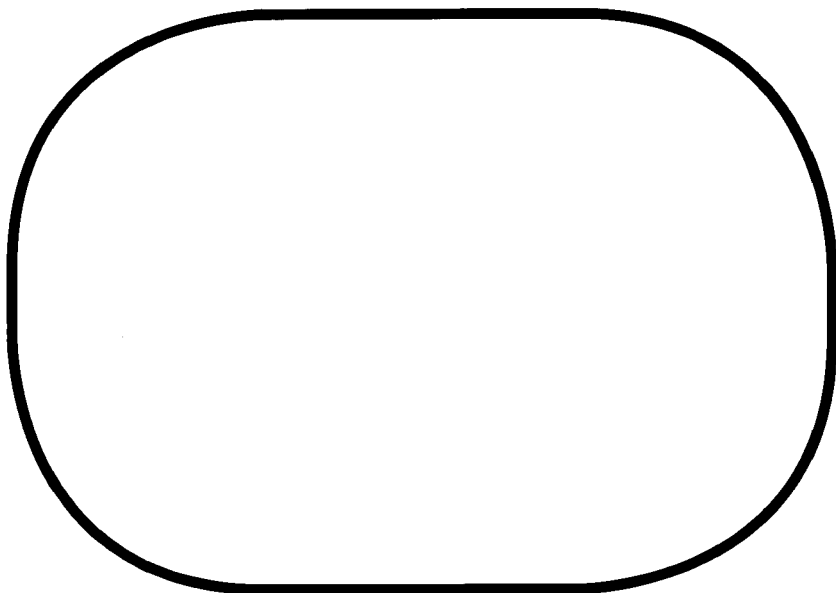
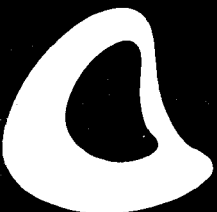

MANUFACTURED
IN NEW ZEALAND
BY POOL-QUIP

 **Paramount
pools**



A few important safety hints

1. CHECK your pool to ensure you meet fencing requirements.
2. NEVER leave a child to swim or even play around the pool unattended – even to answer the telephone .
3. Make sure that at least one person on hand knows rescue breathing and basic first aid.
4. When planning the location of your pool please remember that some form of protection is vital. With sunken pools this should be some form of fencing, while the above-ground type should at least have an anchored cover. This will not only protect your own child, but also keep outsiders away, especially when you are absent.
5. Display emergency telephone numbers, safety and rescue breathing instructions for all to see, as well as basic life-saving equipment.
6. Have a responsible adult teach swimming and water safety.
7. NEVER leave non-swimmers alone with floating toys, or so called inflatable swimming aids. Many of these have proved fatal. When buying, buy with safety in mind – think of any consequences first!

Enjoy your swimming safely!

INSTALLATION INSTRUCTIONS

The installation of your pool is a simple step-by-step procedure. To avoid delays and incorrect assembly, it is important to follow the instructions. If there is something you don't understand, please check with your supplier before going ahead.

PLEASE NOTE

1. Check with your Council regarding a permit and fencing requirements.
2. Check the delivery of pool components – see that everything has been delivered.
If there is something missing, get in touch with your supplier immediately.
3. Order sand, cement and earth for coving as required.
4. Mark out pool location.
5. Prepare site.
6. Set out the final pool dimensions.
7. Assemble frames for pools.
8. Assemble pool ladder.
9. Deepen or dish centre if required.
10. Install wall – First decide on filter location.
11. Cut wall for surface skimmer or knock out plumbing.
12. Prepare cove and spread sand on base.
13. Install ground cover and bolt strip.
14. Install liner.
15. Check and secure liner.
16. Fit vertical supports.
17. Fit top rails, vertical and seats.
18. Fit plumbing or filter.
19. Fence pool.

≈ SALT CHLORINATION SYSTEMS CANNOT BE USED ON PARAMOUNT POOLS.

≈ THE WARRANTY IS CANCELLED IF SALT SYSTEMS ARE INSTALLED.

≈ DO NOT SUPPORT DECKING OR PAVING ON THE TOP RAILING OF THE POOL.

≈ THE POOL MUST BE ABLE TO BE DISMANTLED AT ALL TIMES.

MODEL No.	NOMINAL POOL SIZE	CAPACITY
161248	4.9 x 3.7 metres	16200 litres
201248	6.1 x 3.7 metres	22295 litres
241248	7.3 x 3.7 metres	27300 litres
231548	7.0 x 4.5 metres	33150 litres
271548	8.1 x 4.5 metres	36000 litres
301548	9.1 x 4.5 metres	43225 litres
381548	11.6 x 4.5 metres	54000 litres

LIDO Pool

1. BUILDING PERMIT

Check with your local Council. A building permit may be required or it may be necessary to meet Drainage Board regulations. The Fire Department may also require notification. Most Councils know and understand the construction of pools and are usually most helpful.

3. ORDER SAND, PREMIX AND CEMENT

When ordering sand, cement and premix check first to see that you have the required tools and aids for site preparation. You need a straight edge 100mm x 50mm x 3200mm long; a carpenter's level; a line level; hammer; screwdriver; spanner; a 16 m measuring tape; ball of string; a dozen stakes (about 300mm long); roll of adhesive tape; spade; tamping tool or roller; two pieces of hardboard approximately 600mm x 600mm; concrete slab for filter base.

CODE	POOL SIZE	SAND	CEMENT	PREMIX
1612	4.9mx3.7m	1.25cu.m	One bag	0.3cu.m
2012	6.1mx3.7m	1.50cu.m	One bag	0.5cu.m
2412	7.3mx3.7m	2cu.m	One bag	0.5cu.m
2315	7.1mx4.5m	2cu.m	Two bags	0.75cu.m
2715	8.1mx4.5m	2.5 cu.m	Two bags	1.0cu.m
3015	9.1mx4.5m	3cu.m	Two bags	1.0cu.m
3815	11.5mx4.5m	4cu.m	Three bags	1.5cu.m

2. DELIVERY CHECK LIST

Lido	1612	2012	2412	2315	2715	3015	3815
2 cover plate	2	4	6	4	6	8	12
3 metal thread screw self tapping	10	12	18	18	18	24	30
4 joiners	20	20	20	24	24	24	24
5 connector plate	4	8	12	8	12	16	24
5a stirrup connectors base channel	2	4	6	4	6	8	12
6 rails small radius	24	24	24	28	28	28	28
6a rails large radius oval pool only	-	4	8	4	8	12	20
7 coping strips	24	28	32	32	36	40	48
8 pool liner	1	1	1	1	1	1	1
9 pool wall size	1	2	3	3	3A	4	2x1
10 vertical support - Lido	10	10	10	12	12	12	12
10a vertical supports	2	4	6	4	6	8	12
11 plastic cover strip	1	1	1	1	1	1	1
12 wall nuts, bolts and washers	45	45	45	45	45	45	90
13 liner repair kit	1	1	1	1	1	1	1
14 grommets	9	40	40	40	48	48	48
15 diagonal brace	2	4	6	4	6	6	12
16 base channel	2	4	6	4	6	8	12
17 pressure plate	2	4	6	4	6	8	12
18 skid member	2	4	6	4	6	8	12
19 bolts, nuts & washers (frame)	12	16	24	16	24	32	48
20 skid member bolts	4	8	12	8	12	16	24
21 nut	16	24	36	24	36	48	72
22 washer	32	48	72	48	72	96	144
23 spacer	9	16	24	16	24	32	48
24 bolt (pressure plate)	4	4	4	4	8	12	20
25 nut	4	4	4	4	8	12	20
26 washer	4	4	4	4	8	12	20
27 ground cover	1	1	1	1	1	1	1

Before commencing your pool installation, check the following: -

POOL CARTONS

The table to left shows how to select your pool parts. Follow the line on which your pool size is shown. The numbers indicate the number of pieces of that component.

If package deal purchased, check also for:- FILTER SYSTEM, LADDER, CHEMICALS AND ACCESSORIES, GROUND COVER.

When opening the cartons check off the parts against the parts list. For filter components check the instruction sheet packed with the filter.

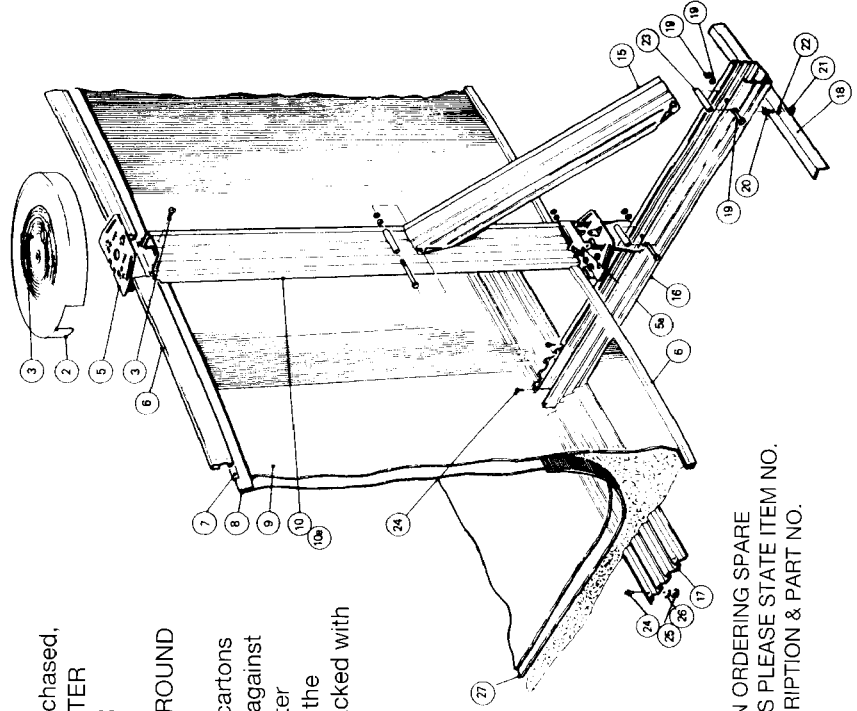

WHEN ORDERING SPARE PARTS PLEASE STATE ITEM NO. DESCRIPTION & PART NO.

4. MARK OUT POOL LOCATION

In positioning pool, ensure that its location meets all Council By-Laws.

IN PLANNING THE LOCATION OF YOUR POOL KEEP WATER SAFETY IN MIND, MAKE PROVISION FOR CHILD PROOF FENCING.

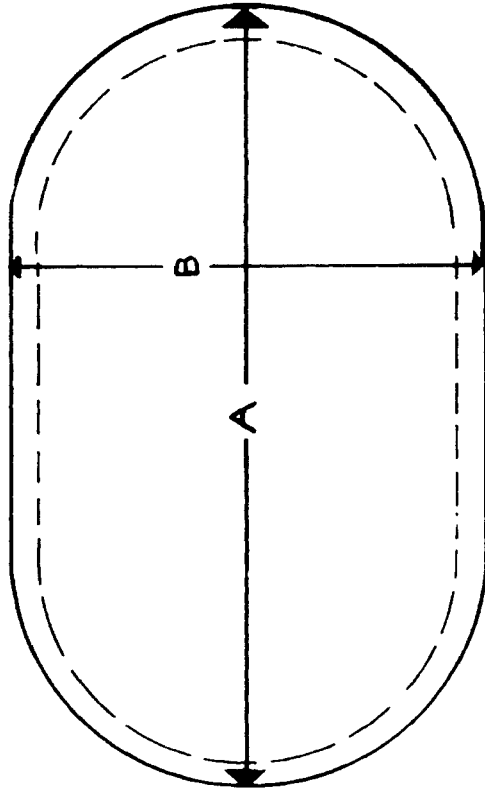

OVAL POOL

Mark out oval slightly in excess of overall length and width of pool. See page 6 and 7

5. PREPARE AND LEVEL SITE

The ground on which your pool is to be erected must be firm and level within 25 mm. If on sloping ground, level out the high side – do not build up low side as the weight of pool water will cause movement.

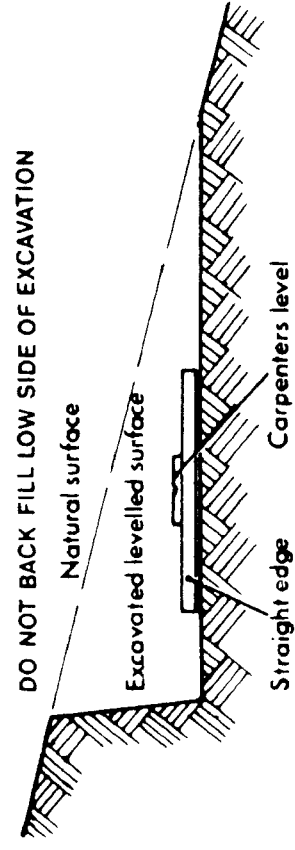

6. Set Out Final Dimensions For Pool Frame

Once the site is satisfactorily leveled, accurately re-mark the final position of the pools as per dimensions on ground plan. The final pool marking should come within the previously levelled area.

Note: Side braces extend 600mm out from pool wall.

CHECK CORNER TO CORNER DIMENSIONS FOR PRESSURE PLATES: IF THEY ARE EQUAL THE FRAMES ARE OPPOSITE AND PARALLEL

CHECK CORNER TO CORNER DIMENSIONS FOR PRESSURE PLATES: IF THEY ARE EQUAL THE FRAMES ARE OPPOSITE AND PARALLEL

CHECK CORNER TO CORNER DIMENSIONS FOR PRESSURE PLATES: IF THEY ARE EQUAL THE FRAMES ARE OPPOSITE AND PARALLEL

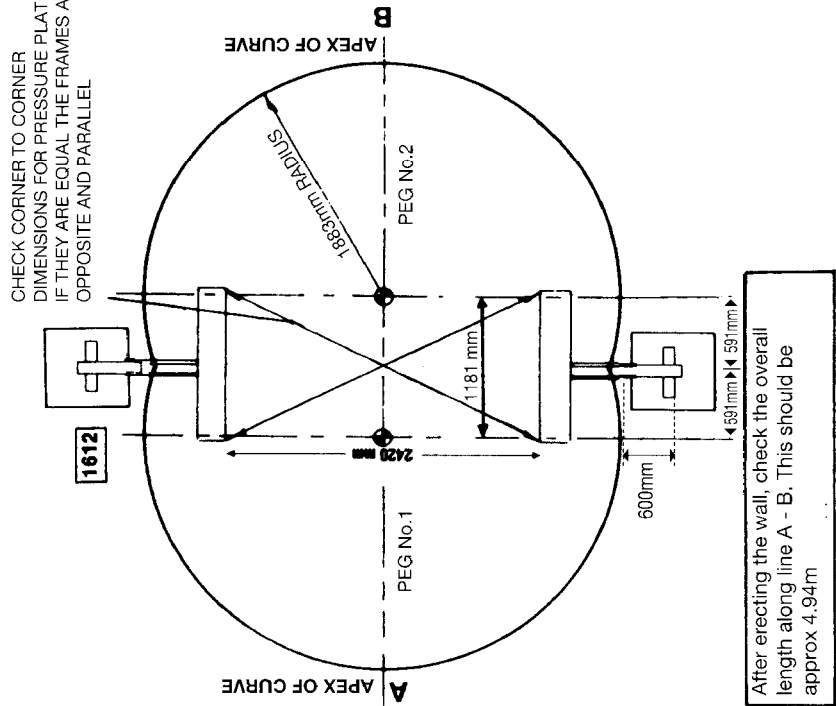
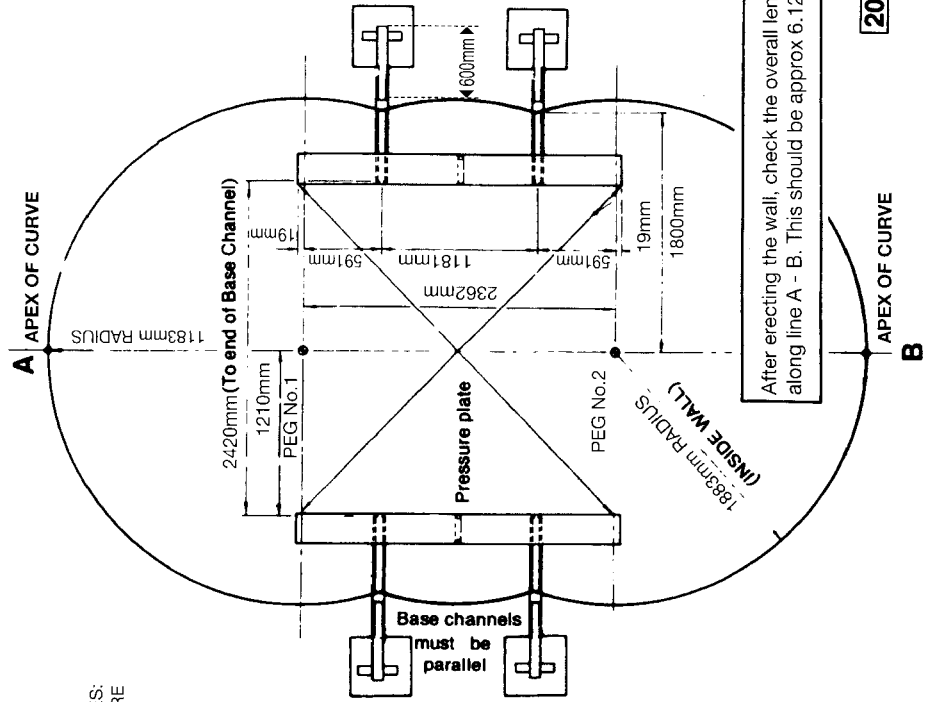
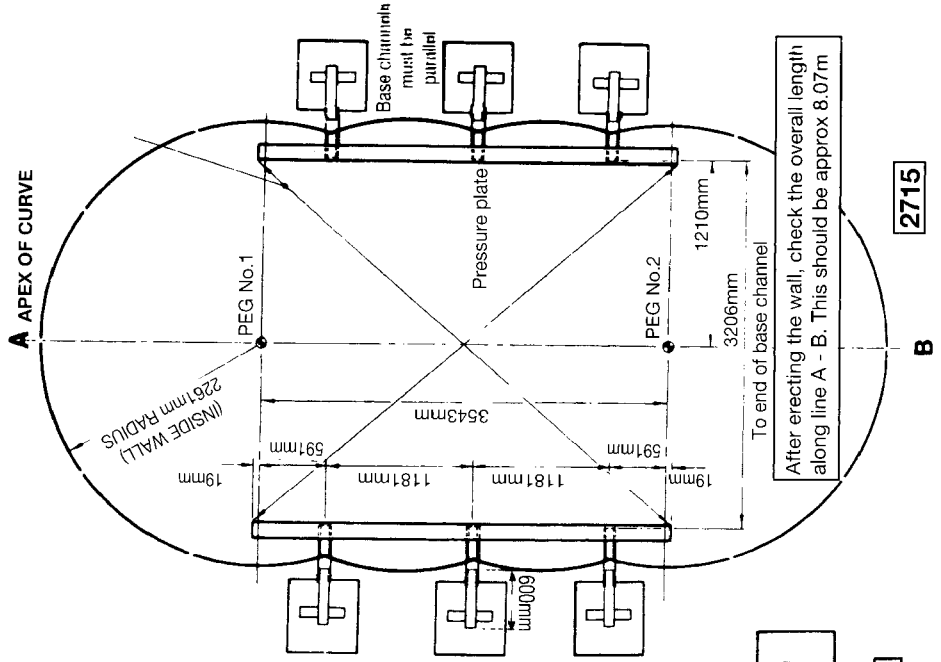

6. Set Out Final Dimensions For Pool Frame

Once the site is satisfactorily levelled, accurately re-mark the final position of the pools as per dimensions on ground plan. The final pool marking should come within the previously levelled area.

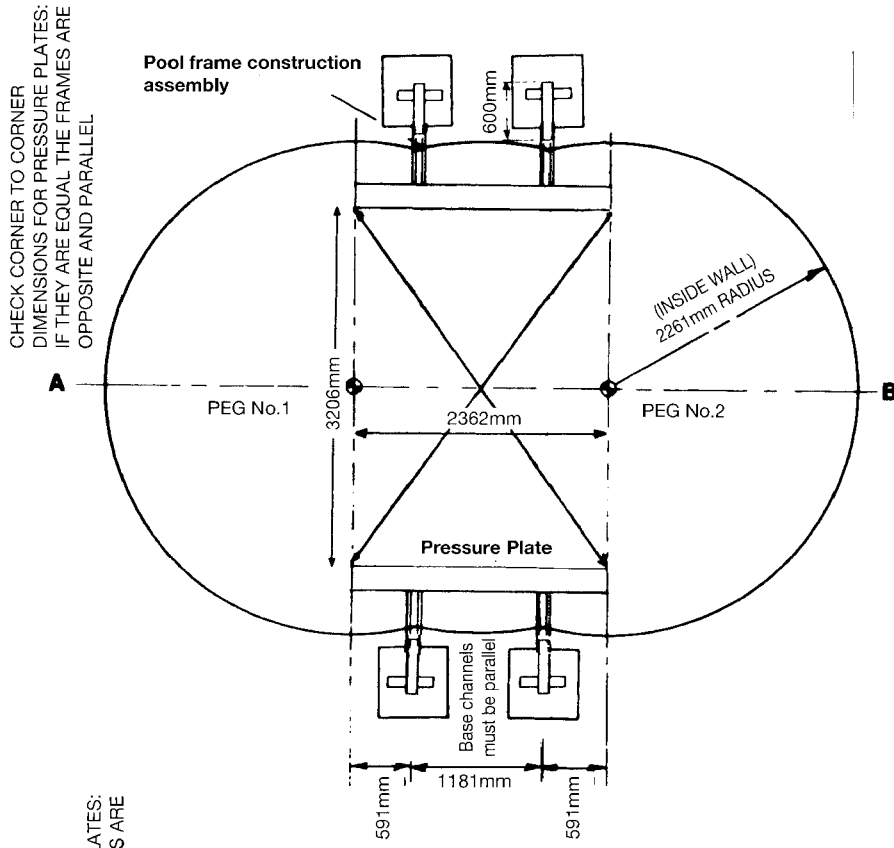

Note: Side braces extend 600mm out from pool wall.

CHECK CORNER TO CORNER DIMENSIONS FOR PRESSURE PLATES: IF THEY ARE EQUAL THE FRAMES ARE OPPOSITE AND PARALLEL

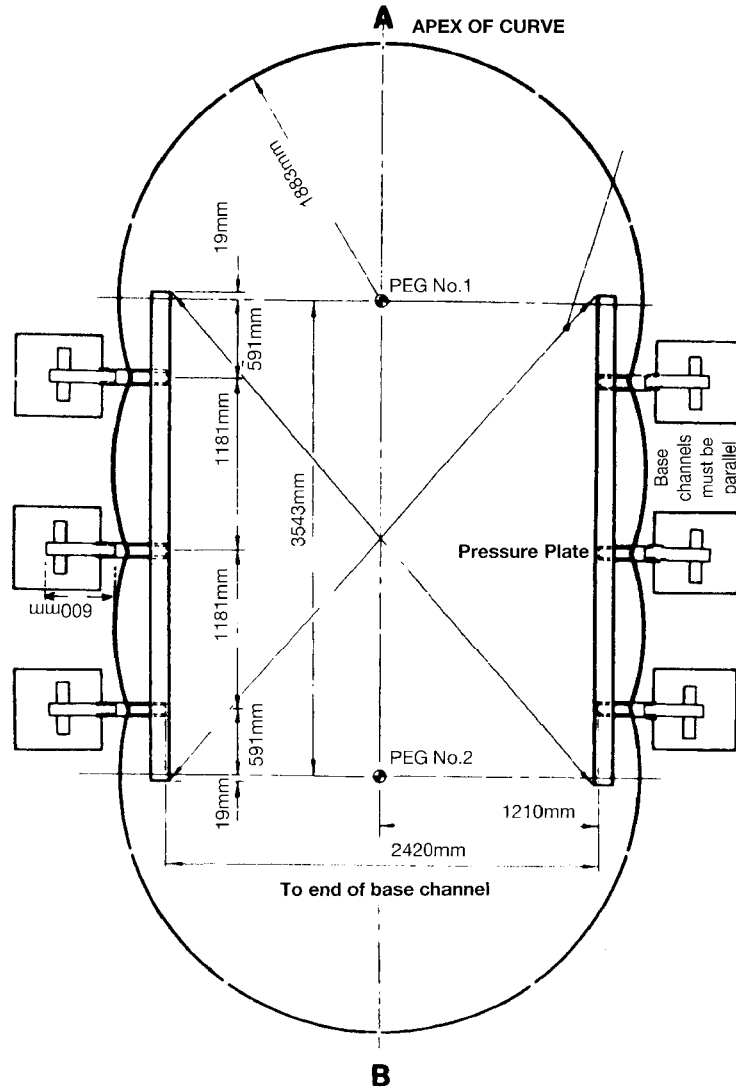

After erecting the wall, check the overall length along line A - B. This should be approx 7.29m

2412

After erecting the wall, check the overall length along line A - B. This should be approx 7m

2315

6. Set Out Final Dimensions For Pool Frame

Note: Side braces extend 600mm out from pool wall.

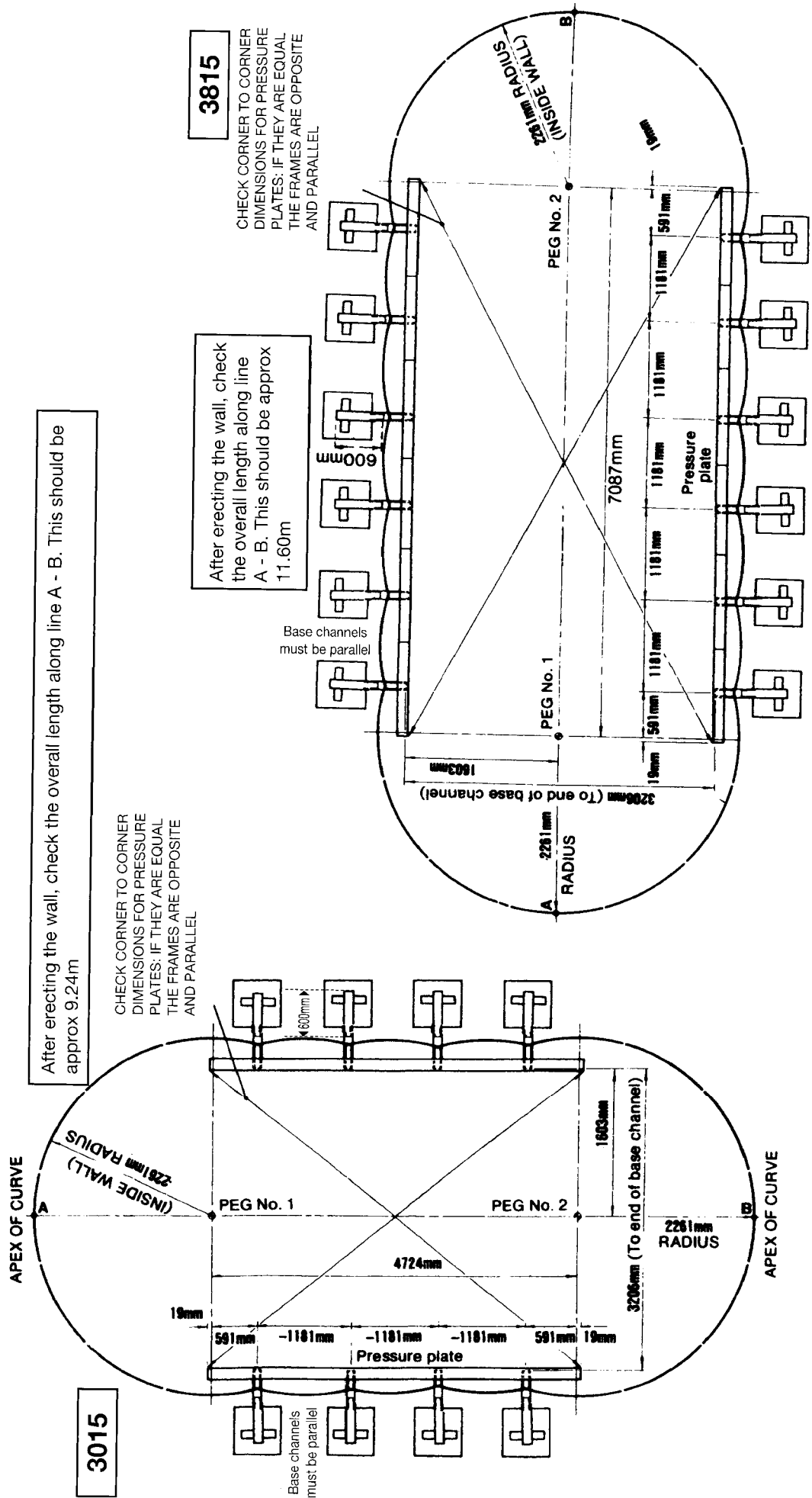

LIDO Pool

1 You will require the following items to successfully complete your installation.

Tools

- Straight edge 100mm x 50mm x 3200mm long
- Carpenter's Level
- Line Level
- Hammer
- Screwdriver
- Small Side-cutters (Tin Snips)
- Rounded File
- 16m measuring tape
- Ball of String
- 1 dozen stakes (about 300mm long)
- Roll adhesive tape
- Spade, Tamping Tool or Roller 600mm x 600mm x 50mm
- Concrete Slab (Filter Installation) if required
- 2 pieces Hardboard (approximately 600mm square)

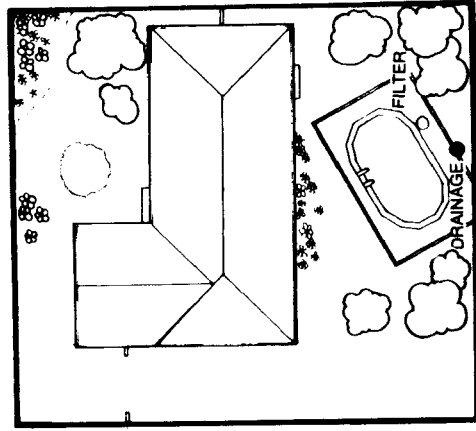
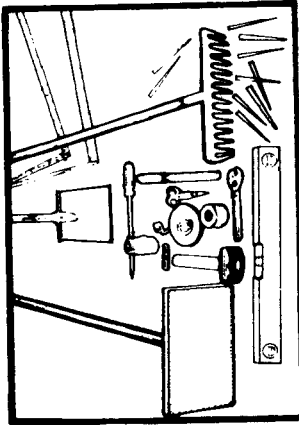

Shown to left is a suggested site plan showing filter position, drain point and restricted access to pool from outside property boundaries.

Preparation of Site



2. Caution: Do not erect your pool on gravel, asphalt, tar paper or any oil based materials.
It is essential that all traces of hardy weeds be completely removed from under the pool as they may puncture the liner. Vegetation such as nut grass or onion weed must be poisoned with Methyl Bromide or similar potent weed killer before clearing the site. Be sure your pool area is free from stones, sticks, wire, roots and other sharp objects.
Concrete is acceptable provided a bed of builders' sand is used under liner.

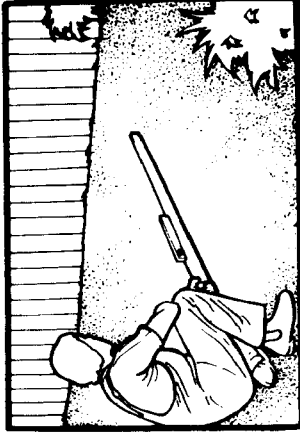
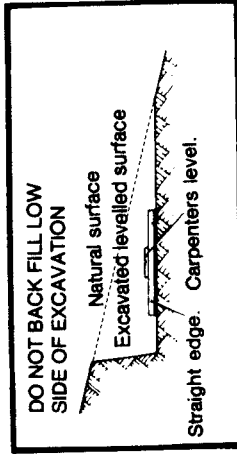

3. Preparation of Site

The ground upon which your pool is to be erected must be firm and level within 25mm. Mark out the required area. If necessary dig out the high side, check with carpenter's level and straight edge. The success of your installation depends entirely on how well the leveling is performed.

Note: Under no circumstances is the low side of the selected site to be built up. The weight and movement of the pool water will ultimately pack down the filling, causing the pool to sink.

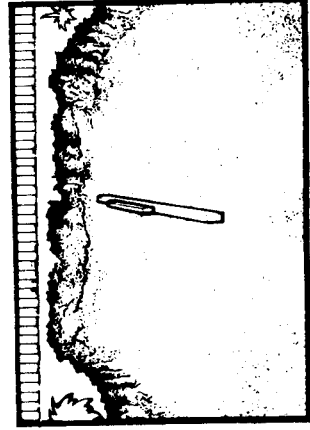

7. Assemble Frames for Pools

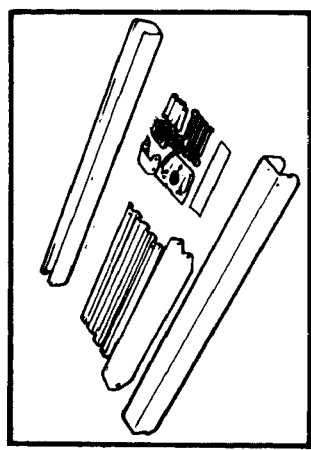

4. Preassembly of side support frame

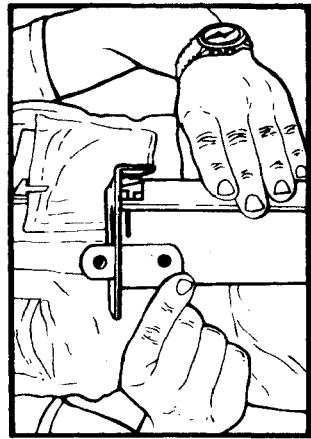

7. Push base channel connector (5a) down through connector plate.

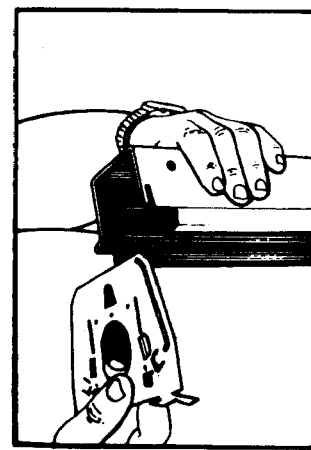

5. Fit connector plate (5) onto the bottom of vertical support (10a).

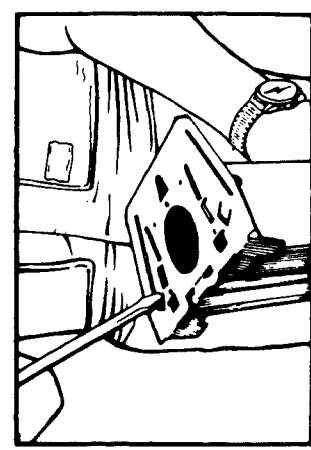

6. Push tabs to hold connector plate in position.

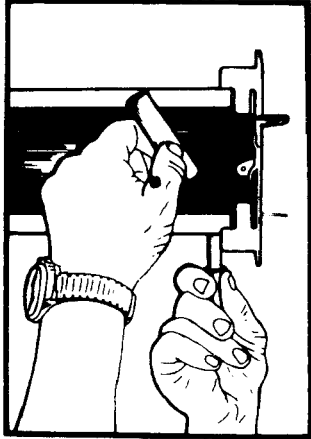

8. Place spacer (23) inside vertical support.

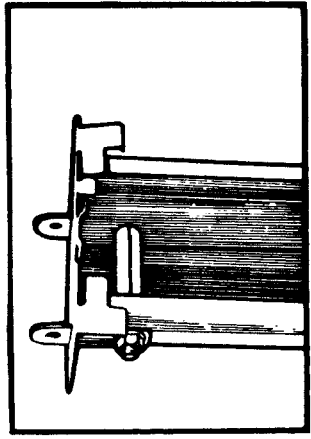

9. Secure connector and vertical with long bolt (19) making sure that the bolt goes through the spacer. Loosely tighten with nut and washer.

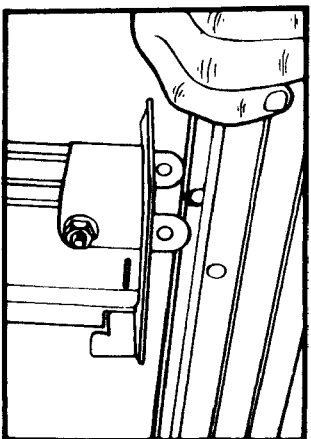

10. Push vertical and connector onto base channel (16).

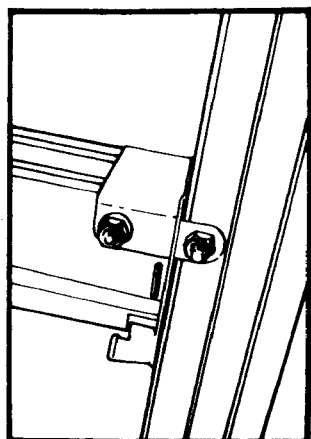

11. Fasten loosely with bolt, spacer, nut and washer. **Note:** Make sure that the open side of vertical is facing the 4 small holes in base channel.



12. Connect diagonal brace (15) onto vertical and base channel using long bolts, spacer, nuts and washers (19). Fit skid member (18) to base channel (16) with bolt (20), nut (21) and washer (22).

Preliminary frame excavation.

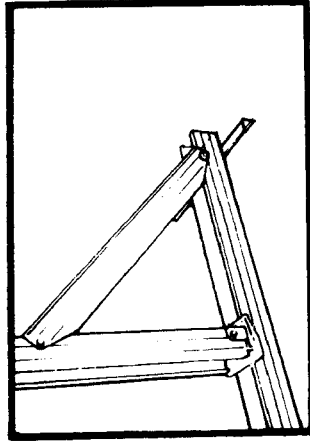

13. Place one complete pool frame construction assembly into position.

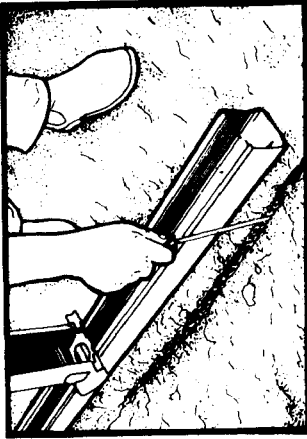

14. Mark the ground around the assembly

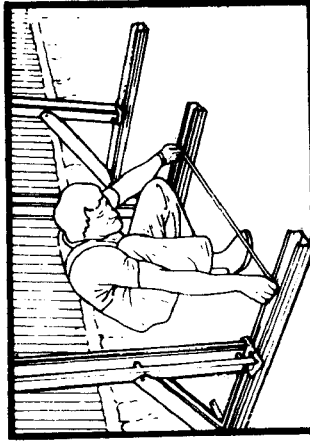

15. Place the pool frame construction assembly with 1181mm centre distance from last position.

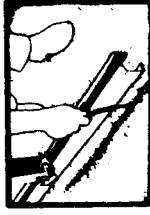

16. Repeat the procedure of step 13, 14 and 15 until all the pool frame construction assembly for your size pool is accounted for. At this stage temporarily install connectors to aid in finding alignment and levels.

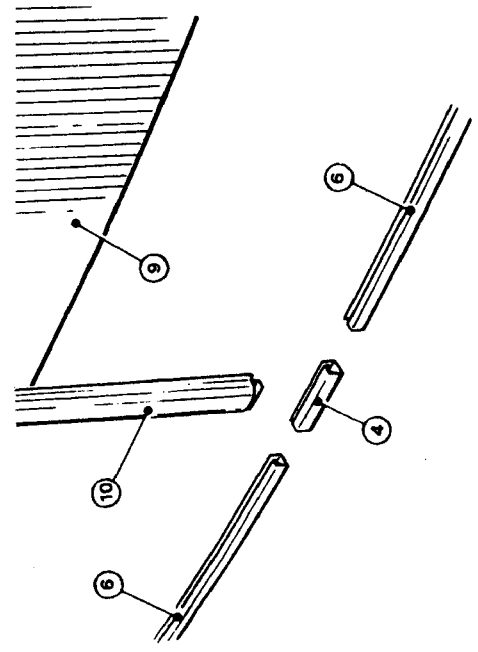
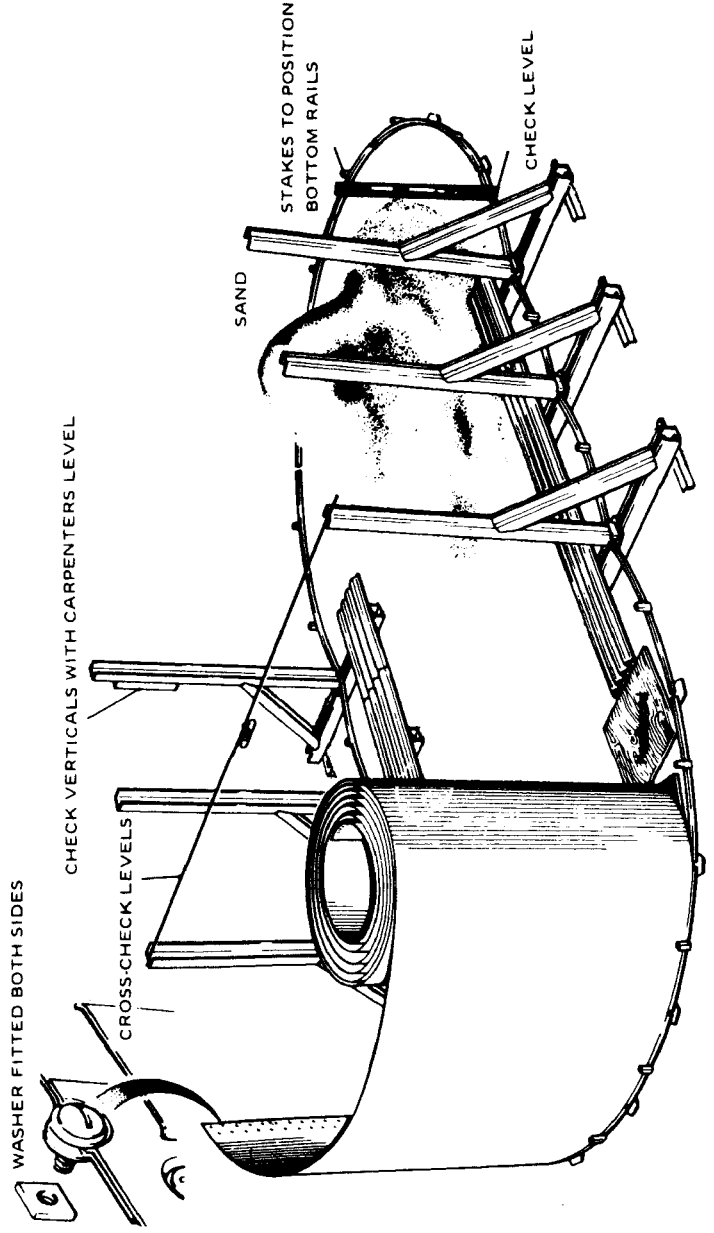

ASSEMBLY OF LOWER RAILS & CONNECTOR

LIDO Pool

17 Remove frame assembly.

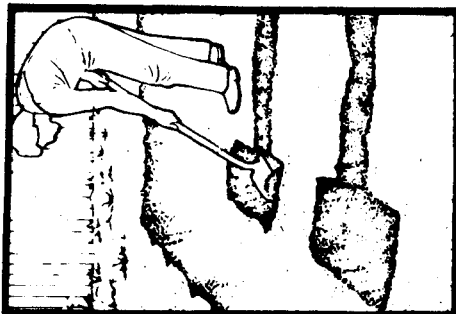

18 Excavation trenches for the base channel 76mm wide x 76mm deep.



19 Excavate the holes for the skid members 457mm x 457mm x 457mm for concrete.

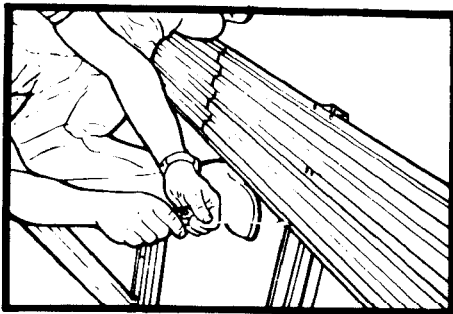

20 After excavations are complete, assemble the pressure plates to the pool frame constructions. Using the 4 self tapping screws (3) attach the pressure plate (17) to the base channels (16). Using the bolt 24 connect pressure plates together. Tighten with washer (26) and nuts (25).

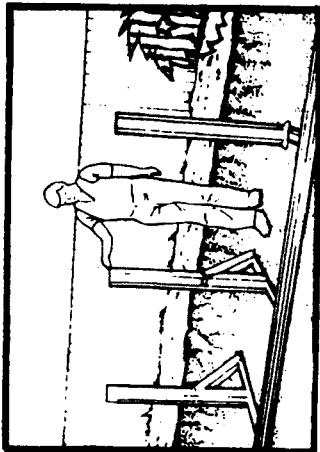

21 Position frames into the excavated holes.

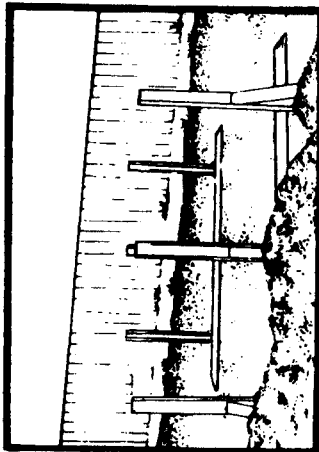

22 Install to measurements shown on ground plan. Pressure plates must be resting on ground level.

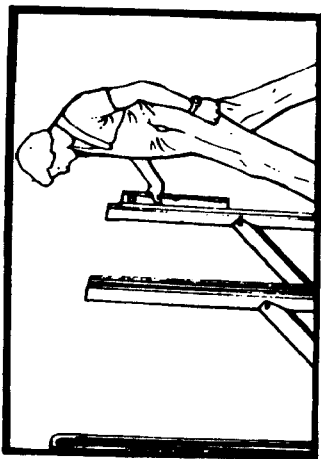

23 Check whether all uprights are level, in line, and level with each other.

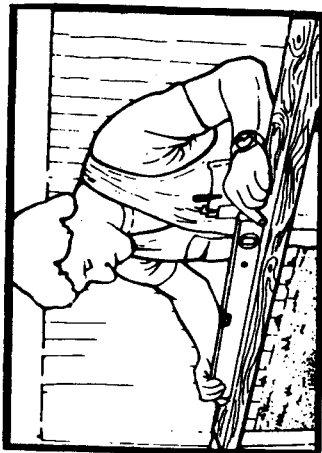

24 Check decks horizontally (trim excavation to suit). Use a level and piece of timber.



25 Use a line level to check levels across pool to opposite frames.

LIDO Pool

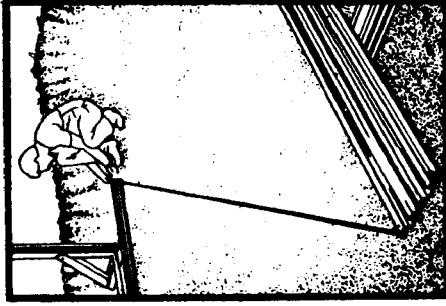
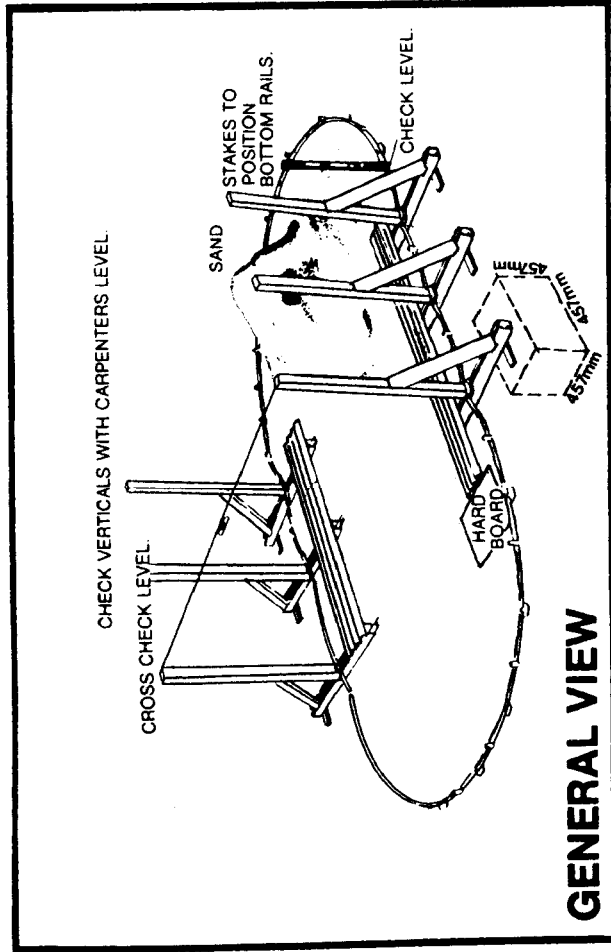

27 Check opposite corner to corner measurements.

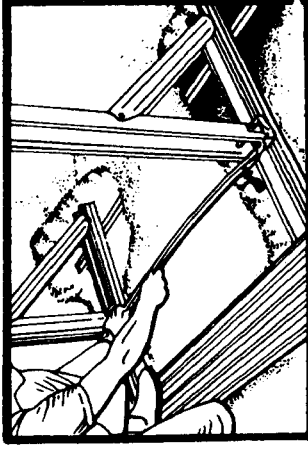

29 Note: It is imperative that there is a solid concrete square behind skid member

30 If the plates are installed on soft fill the weight of water can make the vertical shift out of level. If in doubt pack a small batch of concrete under plate. (17)



28 Your pool is now ready to concrete. Check vertical levels before concrete hardens and pour concrete into excavated holes to ground level.

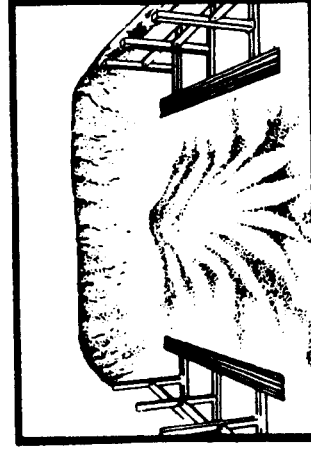

31 Place the required amount of Sand inside the pool.

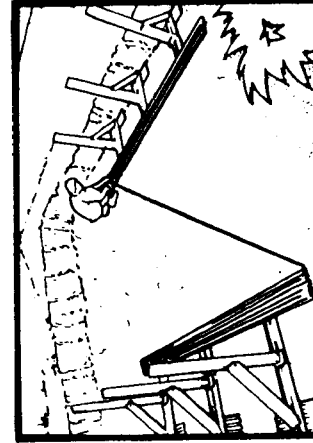

26 Check corner to corner measurements as per ground plan. The measurement should be the same to have the frames square.

LIDO Pool

Sidewall Assembly

32 and 33 **Note:** During assembly take special care when handling the sidewall. Careless handling may result in a buckled wall. Two or three neighbours or friends would be a great help when erecting. Assembly on very windy days should be avoided. If a colourband wall is being installed, select colour preference and unroll accordingly.

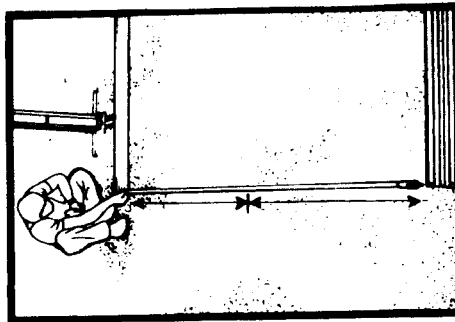

Locate Centre Point Between Pressure Plates.

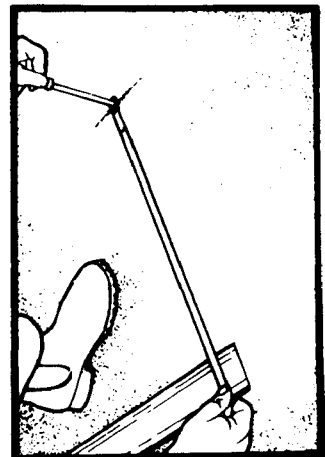

Centre Point is 1603 mm from pressure plate.

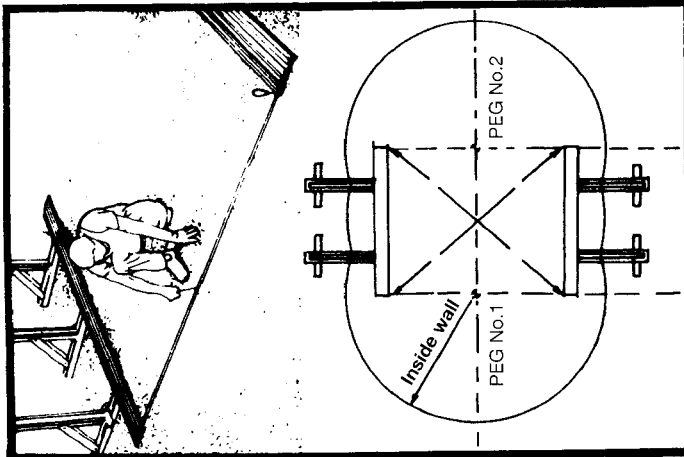

34 Locate peg positions 1 and 2 as shown in ground plan.

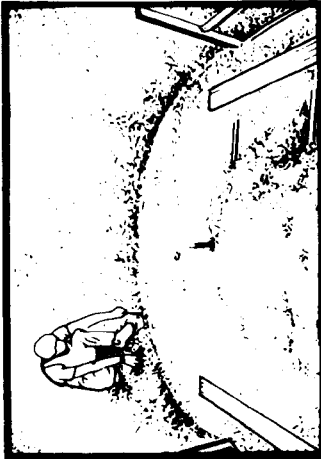

35 Tie a marker (screw driver) to one end of string line and from each peg scribe the required end radius measurement. This will be a guide for laying the base rail.

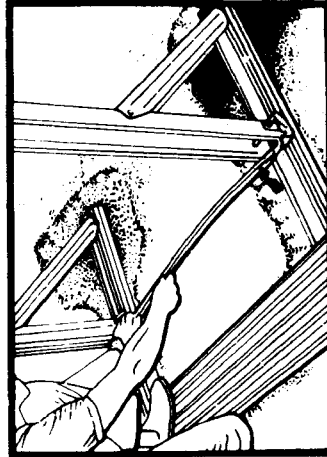

36. Select and install bottom rails for between side supports; these rails have a larger radii than the end rails.
 2012 = 2 rails, 2315 = 2 rails
 2412 = 4 rails, 2715 = 4 rails
 3015 = 6 rails, 3815 = 10 rails



37 Slide the end rails into the connectors leaving approximately 32mm gap between them, and position with stakes so the rails conform to the radii marked out previously.



38 Check the distance to the apex of the curve from pegs 1 and 2 making sure the apex is in line with the 2 pegs (see ground plan).

8. ASSEMBLE LADDER

Option 1:

Safety ladder designed for a pool installed in an above ground situation.

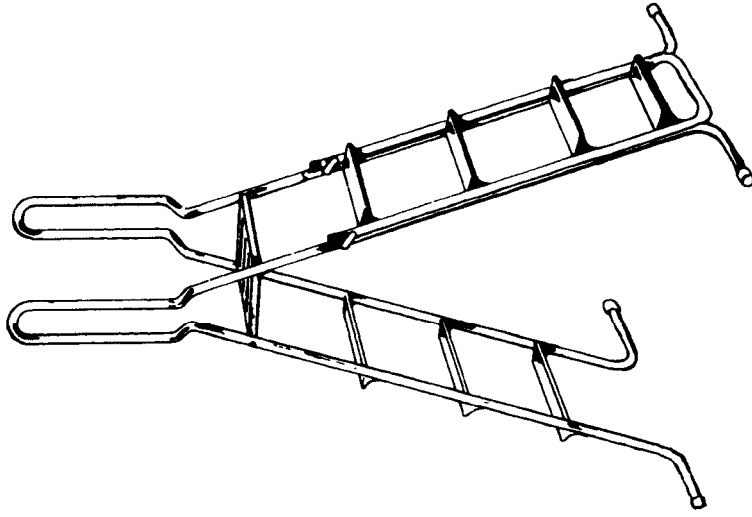

Option 2:

Stainless steel ladder specially designed for your inground pool.

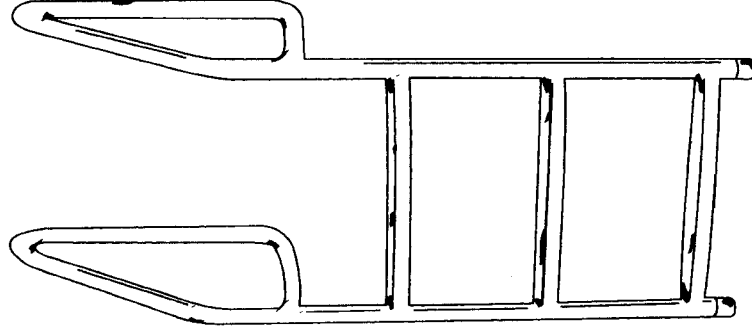

Please Note: You must provide access to and from pool during installation.

9. DEEPEN POOL CENTRE

Although the depth of your pool is designed to suit most family needs, greater depth can be had by excavating from the centre. It is most important that excavation is restricted to a maximum of 500mm below the base level and it is confined to the centre of the pool. If the excavation extends beyond recommended measurements, it could weaken the wall of the pool and warranty will be void.

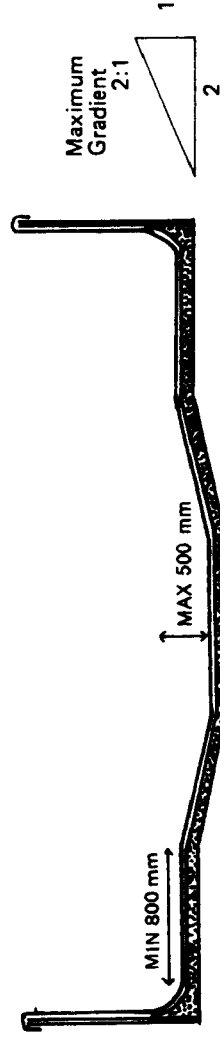

10. Install Walls

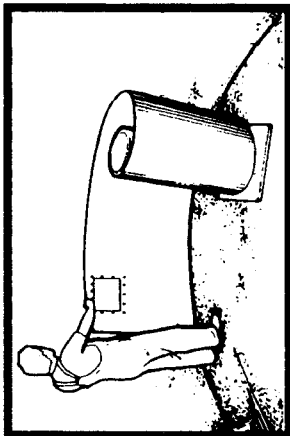

39 The Paramount pool wall is supplied with a pre-stamped, cut out section, sized for the Paramount SP1500 Surface Skimmer. It is positioned 600mm from the outside end of the coiled wall. Before installing the wall into the rails, ensure wall is correct way up and you are starting in the desired place.

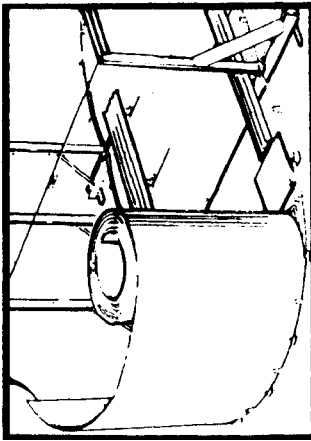

40 Use 2 pieces of hardboard, or similar, about 61cm square. One to stand the coiled wall on, the other to move it onto as you progress.

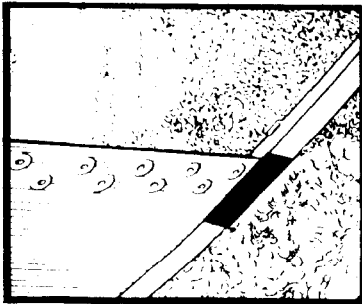

41 The joint should be hidden behind a vertical support (10) page 9, start uncoiling the wall with the end directly over a connector thus covering joint by a vertical. It is advisable to have someone hold the end of the wall to prevent it creeping along in the rail.

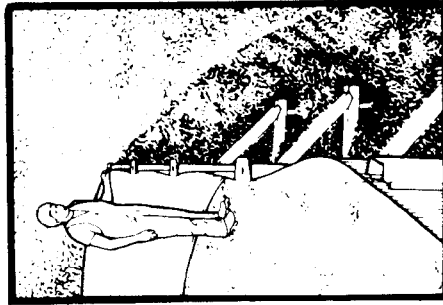

42 A few rails (6) may be placed on top of the wall to give rigidity whilst uncoiling. On reaching the end of the rail the bolt holes may not line up. This alignment is achieved by moving the rails in or out to suit.

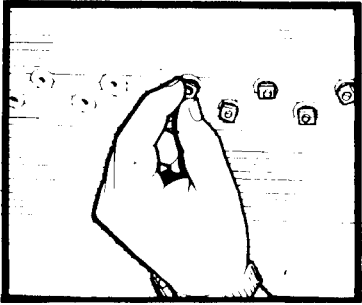

43 When the holes do line up, loosely assemble all the bolts, nuts and washers.

Note: It is important to fit a washer to each side of the wall and have a bolt head inside the pool. Firmly tighten all nuts.

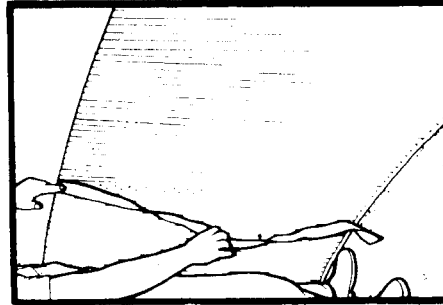

44 Cover the bolt heads with the plastic cover strip (11).
45 Tape it firmly into place starting from the bottom. Cut off 25mm from the top.

11 Cut wall for the plumbing of the eyeball returns

Although the pool wall is supplied with the surface skimmer section pre-punched, the eyeball holes are not cut.

This is to allow you to custom fit the eyeball returns (2) in the most suitable position.

NOTE - It is essential that the cutting of the wall for these eyeballs is done at this stage of the pool wall installation, so all metal filings and off-cuts etc, cannot damage the pool liner.

Procedure - Position the eyeballs where required.

- **Oval pools;** position both eyeball returns at the opposite end to the surface skimmer
- **Round pools;** position the eyeball returns approximately 120° and 240°, around from the surface skimmer.

It is recommended to fit the eyeballs at a distance of 200 to 300mm down from the top rail.

Cut a 48mm diameter hole for each eyeball with suitable small side-cutters (Tin Snips) or similar, remove all metal burrs and sharp edges with a round file, check hole sizing with actual eyeball before continuing.

DO NOT INSTALL SURFACE SKIMMER OR EYEBALLS AT THIS STAGE.
This is done at Step 18.

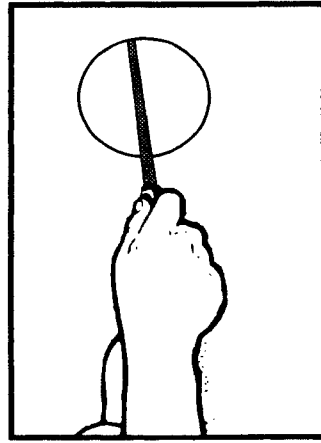

12 Prepare cove and spread sand on base

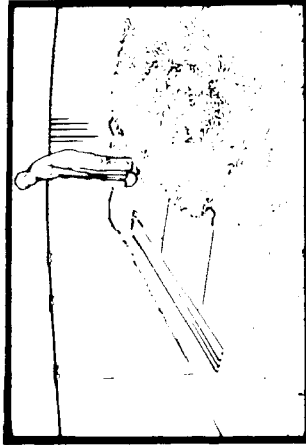

46 Before spreading sand over floor unscrew pressure plates and fill base channel and pressure plate areas with sand to prevent any movement.

Re-install pressure plates
Note: It is very important that this step be done correctly. The sand has to be packed tightly to eliminate movement of pressure plate when walked upon.

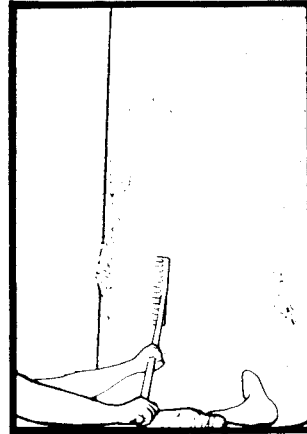

47 Build up an even cove of firm sand or earth around the wall of the pool approximately 150mm and pack firmly.



48 Spread the sand over the entire floor area to an even depth of approximately 50mm making sure you have 50mm of sand over the pressure plate.

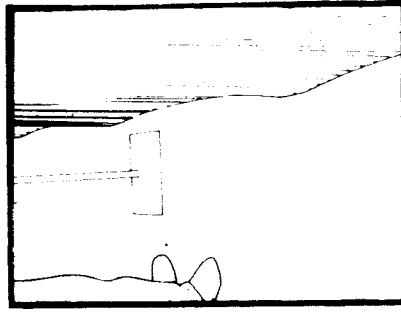

49 Compact the sand on the floor by tramping or rolling until a footprint no longer shows.

13 Install ground cover

50 **Installation of liner**
 Remove all seats and connector plates.



51 Place the pool pad (GROUND COVER) over the entire floor area and hold it in position by taping it to the pool wall.

14 Install liner

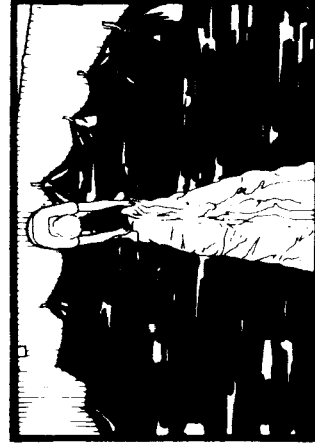

52 Unroll the liner in the centre of the pool with the smooth weld up. (The liner is easier to install if left unrolled in the sun to warm and soften).



53 Position the liner so that wall-floor seam is an equal distance from pool wall at both ends and sides. The liner has several seams running across the pool floor, which must be straight and parallel to side frames.

15 Check & secure liner

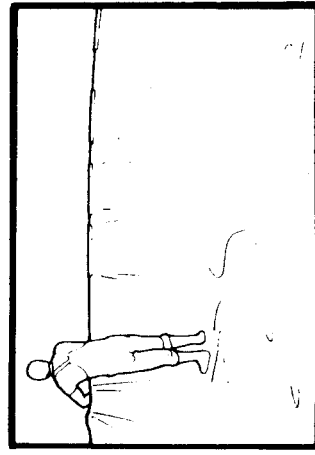

54 Pull the liner wall up over the pool wall and hold in place with the plastic coping strips. (7)
Note: Remove footwear before walking on liner.

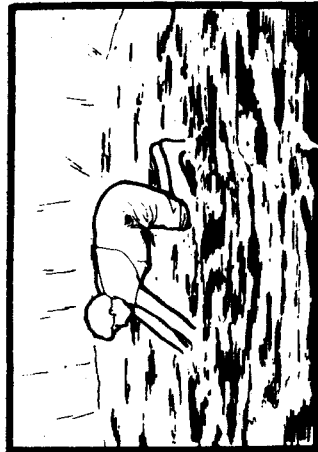

55 Commence running water into pool. When you have approximately 25mm, remove all floor creases by working from the centre to the wall. Remember the more water over 25mm depth, the more difficult it is to remove the creases.

16 Fit vertical support

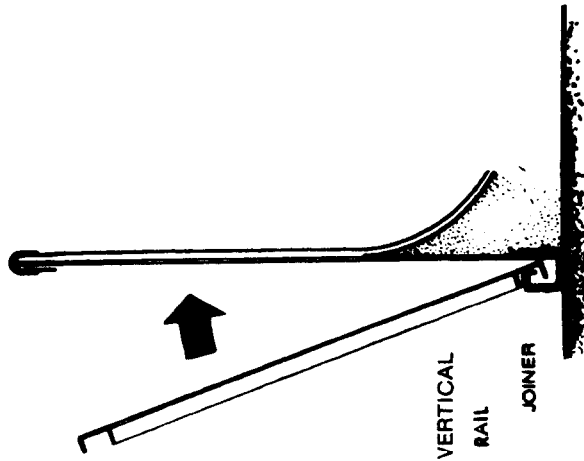

17 Fit top rails /seats

The slim line rail used on all models fits over the plastic coping, each section being joined by a connector rail. Ensure that all top connectors are directly above bottom connectors and the gap is approximately the same. Ensure that all top connectors are directly above bottom connectors and the gap is approximately the same. Ensure that verticals are upright. They can be lightly tapped into position if on an angle. When top rails are satisfactorily fixed, permanently fix all vertical supports between joiners.

Use vaseline on inside slide connector to assist assembly.

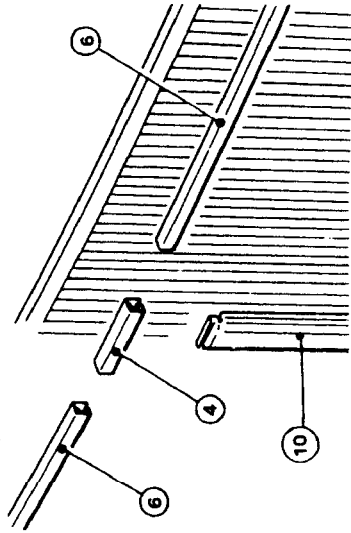

18 Fit Surface Skimmer and Eyeball Returns

Do not install these items until the water level has filled to just below the cut out positions in the wall.

This will ensure the liner is cut with accuracy and lines up easily to the metal cut-outs, reducing chances of unsightly wrinkles around these fittings.

Procedure - Paramount SP1500 Surface Skimmer

Hold the face plate in position through the cut out, pierce the liner through the 15 bolt holes (1) with a pointed spike to allow easy insertion of the bolts.

Place one gasket on the inside of the face plate and carefully insert bolts through, starting with the four corners.

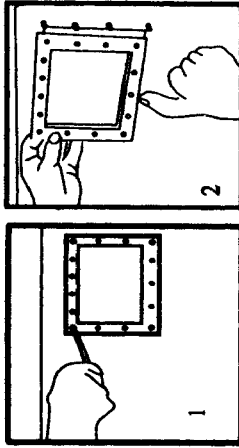

Place 2nd gasket (2) on outside of the wall and then position actual skimmer box on the protruding bolts. Ensure both gaskets have seated properly, fit nuts to bolts and tighten all 15 evenly.

Finally trim the liner around inside of the skimmer mouth, check skimmer basket is locked and position deck lid.

EYEBALLS

Cut the liner to the hole size in the wall. Ensure you cut it the same size or slightly smaller, but not larger.

Fit a gasket to the eyeball, then position eyeball through the liner, then wall. Thread lock nut on and tighten.

Proceed with the connecting of the plumbing. Do not cover pipes until you have run water through the entire filtration system, checking all joins for leaks.

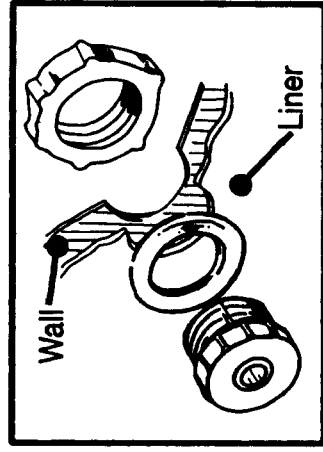

Maintenance

Pool Liners:

DO NOT DRAIN THE POOL.

Leave the pool filled throughout the year, suitably protected by winterizing programme (see Chemical Treatment Brochure). Unless the liner has been damaged and cannot be repaired on site, draining the pool unnecessarily could result in excess liner shrinkage which is not covered under warranty.

If the liner has been damaged repairs should be carried out preferably with the liner in place and removed only if replacement is necessary. If a liner is to be returned under warranty, please contact your local store prior to shipment. Returned liners must be thoroughly cleaned and dried inside and out. Mark the damaged area with a black grease pencil. The liner should be folded neatly and packed securely into a cardboard box marked with return name and address. The pool can be drained by using the vacuum and diverting the return line, or by siphoning.

Replacement Parts: Replacement parts can be ordered from your local store. Include the pool size, part name and number when ordering.

19. Fence Your Pool

Extract from "Guide to Swimming Pool Protection" published by N.Z Water Safety Council.

FENCING

Fences are the most permanent form of physical protection for swimming pools. Because they form a fixed barrier between the pool and its surroundings, they protect all ages, especially the very young. The most effective means of protecting children from drowning in swimming pools is to fence the pool area itself rather than the whole property. As the majority of children are drowned in their parents' pools, a fence which surrounds the whole property only protects other children in the neighbourhood.

Many children drown while playing near the pool rather than using it, so it is important that playing areas are located outside the fence.

SEPARATION OF FENCE FROM THE POOL.

Ideally, a fence should not be less than 1.20 m (4 ft) from the waterline of the pool. If a child managed to climb the fence, this distance would prevent her from falling directly into the pool. It would also prevent older children jumping off the fence into the pool and would ensure enough room for rescue operations should the need arise.

LOCATION OF THE FENCE

When choosing the location of a fence it is important to make sure that objects such as trees with overhanging branches or buildings with balconies are not close. Children can quite easily fall from these into the pool or pool area. It is also important not to leave step ladders or sun-deck chairs near the outside of the fence as this can be used as climbing aids.

TIME OF ERECTION OF FENCE

The fence should be built prior to the building of the pool or as soon as possible after the pool is filled.

HEIGHT

Fences and gates should be at least 1.2 metres (4 ft) high on the outside at any point along their length. They should also allow for space between buildings, trees, terraces, etc.

GROUND CLEARANCE

The gap between the bottom of the fence and the ground should be less than 100mm (4 in).

OUTSIDE SURFACE

The outside surface of all fences should be smooth so children cannot climb them.

HORIZONTAL LENGTHS

All horizontal lengths, such as rails, rods, wires or bracings that could be used as holds for climbing must be placed on the inside of the fence. They should be spaced at least 900 mm (3 ft) apart.

UPRIGHTS

There should not be more than 100mm (4 in) between any uprights, such as palings, rods or wires.

GATES AND FITTINGS

Gates should meet the following additional requirements.

Mounting of Gates

Gates should be mounted so that:

- They only open outwards;
- They are free from any obstruction which could hold them open;
- When pushed inwards or lifted upwards the movement does not release the latching device, unhinge the gate or leave a gap wider than 100mm (4 in).

Latching Device

- Gates should be fitted with an automatic self latching device which can only be released manually;
- The latching device should not be within a child's reach from the outside, but within easy reach from the inside;
- Both the latching device and fence should be able to hold the gate closed.

Automatic Closing Device

All gates should be fitted with a device which will automatically close them.

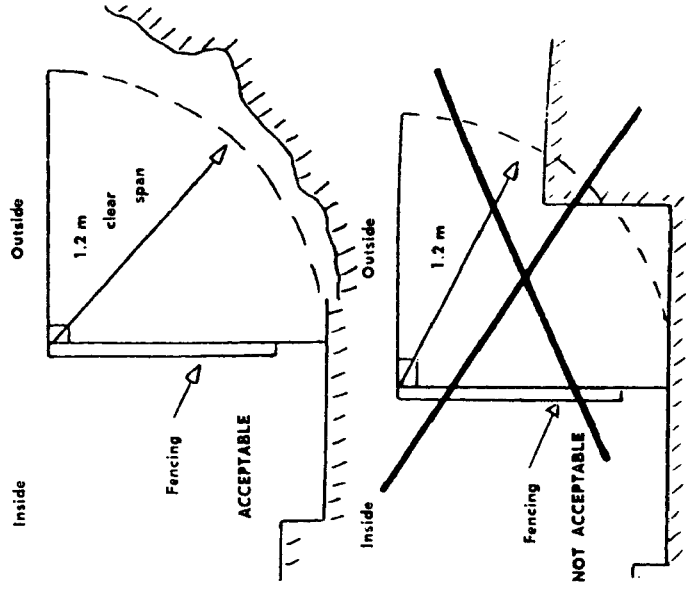

LIDO Pool

Specifications for Fences And Gates

The following specifications have allowed the consumer a great deal of flexibility in choice of fencing, desirable aesthetics and cost.

Design and Construction

Fences and gates should be designed and built so that at any point they prevent small children from climbing under, over or through them.

Materials

The materials used should be highly resistant to the effects of weather, sunlight, pool chemicals and water.

Examples of Pool Fencing

Because there is a wide range of fencing materials available and a variety of ways in which they can be assembled it would be impossible to cover all technical specifications of fencing. This information is intended therefore to serve as a broad guide to some of the main construction standards that the more common types of fencing should meet.

(a) Post and Rail Construction

Fences built of palings or corrugated iron, corrugated asbestos, corrugated aluminium or similar profiled wall material would be suitable, provided that the rails are located on the inside of the fencing. Paling fences would be suitable, provided that the palings are spaced not more than 100 mm (4 in) apart, with the horizontal rails no less than 900 mm (3 ft) apart.

(b) Chain Wire Mesh Fences

Chain wire mesh fences are suitable, provided that the mesh openings are not more than 25 mm (1 in). The mesh must be firmly fixed and tightly

strung with the openings arranged in a diamond pattern.

(c) Fabricated Metal Fences

Fences made from small section steel, aluminium or a similar metal are suitable provided that the uprights are not spaced more than 100 mm (4 in) apart.

(d) Infill Panel Fences

Fences made of glass fibre, reinforced glass, timber ply or similar sheeting built in framed ledges or panels would be suitable. Horizontal holds should be at least 900 mm (3 ft) apart and any openings should be less than 100 mm (4 in). It is important that the sheet metal is rigid and securely fixed to its frame.

(e) Brickwork or Masonry Fences

Fences made of bricks, blocks or masonry would be suitable. Any bricks set in or out of the fence more than 50 mm (2 in) in depth or width, or any openings in the fence, should be at least 900 mm (3 ft) apart. The openings in any type of hollow ornamental brick should not be more than 25 mm (1 in).

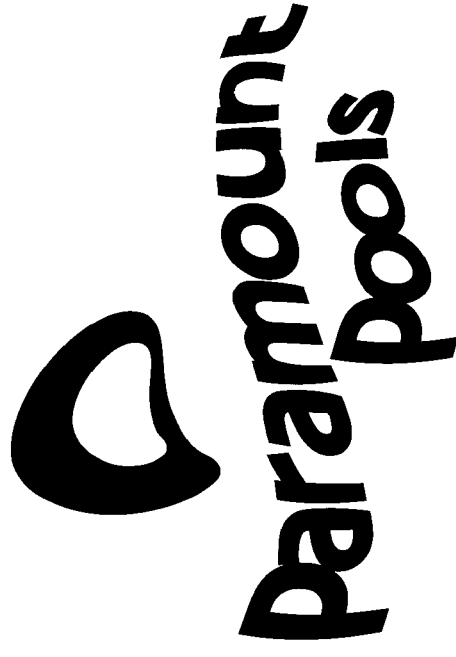

Manufactured in New Zealand By

Pool-Quip

282 Neilson Street Onehunga . PO Box 12-840, Penrose
Auckland 1642, New Zealand
Telephone 64-9-6349097 Facsimile 64-9-6341020

www.paramountpools.co.nz