

EN

Dolphin M400 / M500

User Instruction

Contents

1. INTRODUCTION	2
2. SPECIFICATIONS.....	2
3. WARNINGS AND CAUTIONS	2
3.1 Warnings.....	2
3.2 Cautions.....	2
4. POOL CLEANER PARTS	3
5. USING THE POOL CLEANER.....	4
5.1 Setup.....	4
5.2 Putting the Pool Cleaner into the pool.....	5
5.3 Removing the Pool Cleaner from the pool	6
6. ROUTINE MAINTENANCE.....	7
6.1 Cleaning the filter cartridges	7
6.2 Dismantling and cleaning the impeller	8
7. USING THE REMOTE CONTROL - M500 ONLY	9
8. OFF SEASON STORAGE.....	11
9. TROUBLESHOOTING.....	11
10. CADDY ASSEMBLY INSTRUCTIONS	89

Dolphin M400 / M500

User Instruction

1. INTRODUCTION

Thank you for purchasing a Maytronics Robotic Pool Cleaner.

We are sure that your Maytronics Robotic Pool Cleaner will provide you with reliable, convenient and cost effective pool cleaning. Its reliable filtration in all pool conditions, active brushing, and all-surface climbing brush enhance maximum pool hygiene.

The Robotic Pool Cleaners by Maytronics deliver advanced cleaning technology, long lasting performance and easy maintenance. You and your family will be free to enjoy swimming with full confidence that your pool is completely clean.

2. SPECIFICATIONS

Motor protection: IP 68

Minimum depth: 0.80m/2.6ft

Maximum depth: 5m/16.4ft

Digital switch-mode power supply

- Input - 100-250 AC VOLTS
- 50-60 Hertz
- 180 Watt
- Output - <30 VDC
- IP 54

3. WARNINGS AND CAUTIONS

3.1 Warnings



- Use the originally supplied power supply only
- Ensure the electrical outlet is protected by a ground fault interrupter (GFI) or an earth leakage interrupter (ELI)
- Keep the power supply out of standing water
- Position the power supply at least 3.5m/12ft away from the edge of the pool
- Do not enter the pool while the Pool Cleaner is working
- Unplug the power supply before servicing

3.2 Cautions

When not in use store the Pool Cleaner on its Caddy in a shaded area.

Use the Pool Cleaner in the following water conditions only:

Chlorine	Max 4 ppm
pH	7.0 - 7.8
Temperature	6-34°C / 43-93°F
NaCl	Maximum = 5000 ppm

4. POOL CLEANER PARTS

► Dolphin M400 / M500

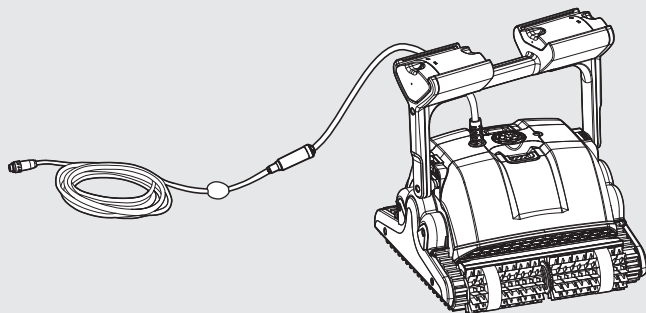

Remote Control Unit - M500 only



► Brushes

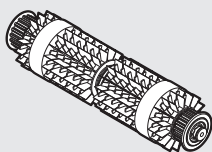

Combined Brush
All surface climbing brush,
ideal for most pool surfaces.

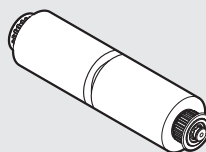

Wonder Brush
For smooth ceramics.

► Filtration

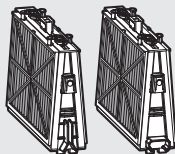

Cartridge with Net filters (X4)

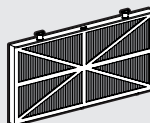

Ultra-fine filter (X4)
(optional)

► Power supply unit - Options

Basic

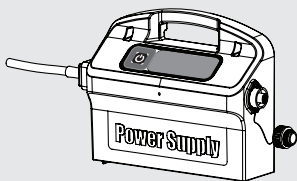

Advanced

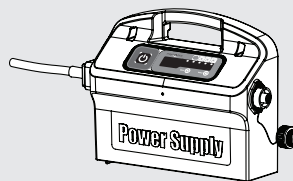

► Caddy

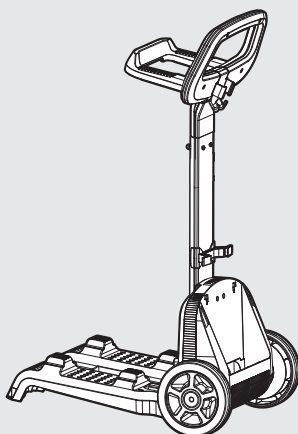

5. USING THE POOL CLEANER

The Pool Cleaner is very simple to use. Simply put it into the pool and make sure that it is properly sitting on the floor of the pool. Turn it ON and let it get the job done.

5.1 Setup

Before using the Pool Cleaner for the first time perform the following steps:

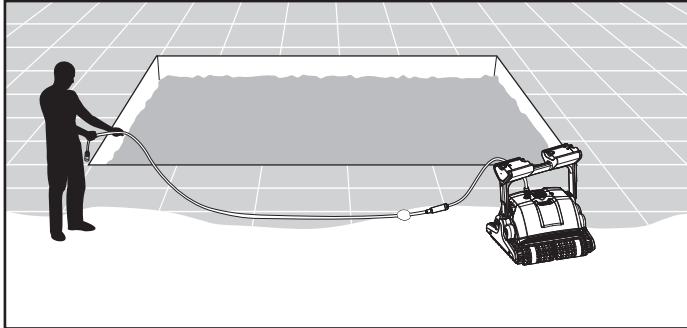

Unwind the cable and stretch it out completely so that it has no kinks.

Some models arrive with plastic coverings on the brushes. Remove them before use.

Adjusting the handle angle

The robot's handle should be adjusted and locked diagonally in order to ensure optimum cleaning results.

The handle angle can be adjusted also to determine the speed at which the robot advances along the water-line.

To adjust the handle angle:

- A. Press the latch down and hold it in position.
- B. Move the handle to the desired position and release the latch to hold the handle in place.

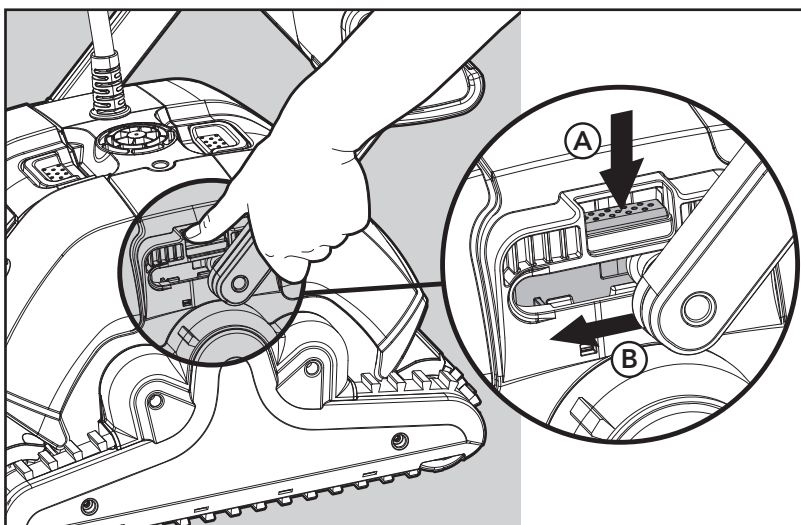

Position the power supply so that it is approximately in the middle of the long side of the pool at a distance of min 3.5m/12ft from the pool and placed 11cm/4" above ground.

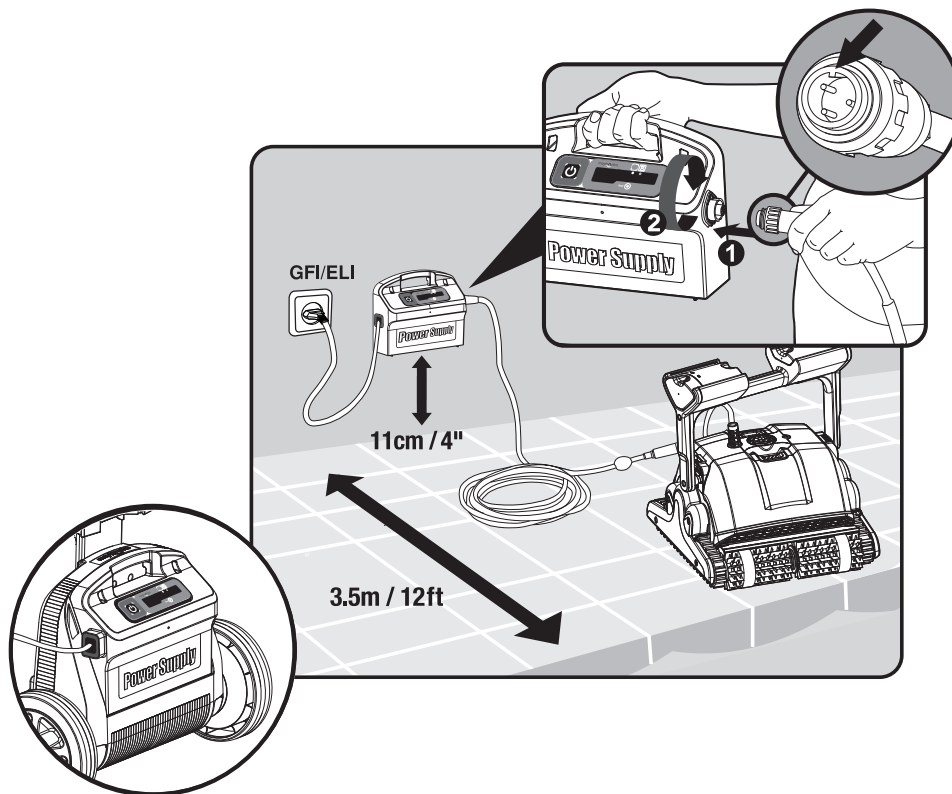

Attach the floating cable to the power supply by inserting it with the notch on the connector (1) lined up with the groove in the socket on the power supply and turning clockwise (2).

Plug in the power supply and leave it in the OFF position.

5.2 Putting the Pool Cleaner into the pool

If your Pool Cleaner is equipped with brushes that contain sponges, dip the brushes in the water and squeeze them so that they will absorb water the first time you use the Pool Cleaner, or if the brushes have dried out between uses.

Release the Pool Cleaner and let it sink to the floor of the pool.

Make sure that the floating cable is free of any obstructions.

To avoid kinks in the floating cable, place approximately enough cable in the water for the Pool Cleaner to reach the farthest corner of the pool.

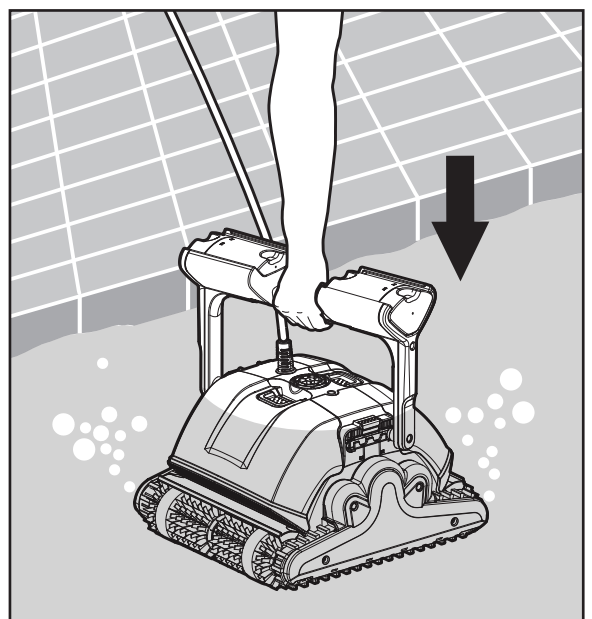

Turn the power supply ON.
The Pool Cleaner will now operate until it has reached the end of the cleaning cycle.

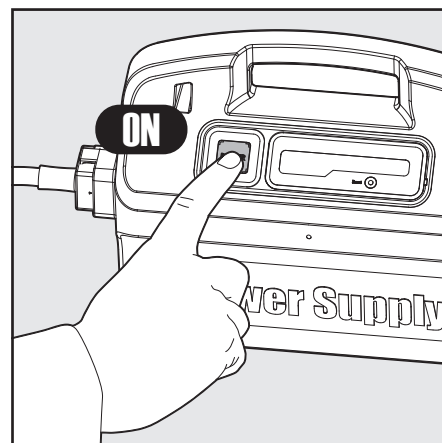

5.3 Removing the Pool Cleaner from the pool

 Turn OFF and unplug the power supply.

Using the floating cable, bring the Pool Cleaner to the pool's edge.

Using the handle remove the Pool Cleaner from the pool.

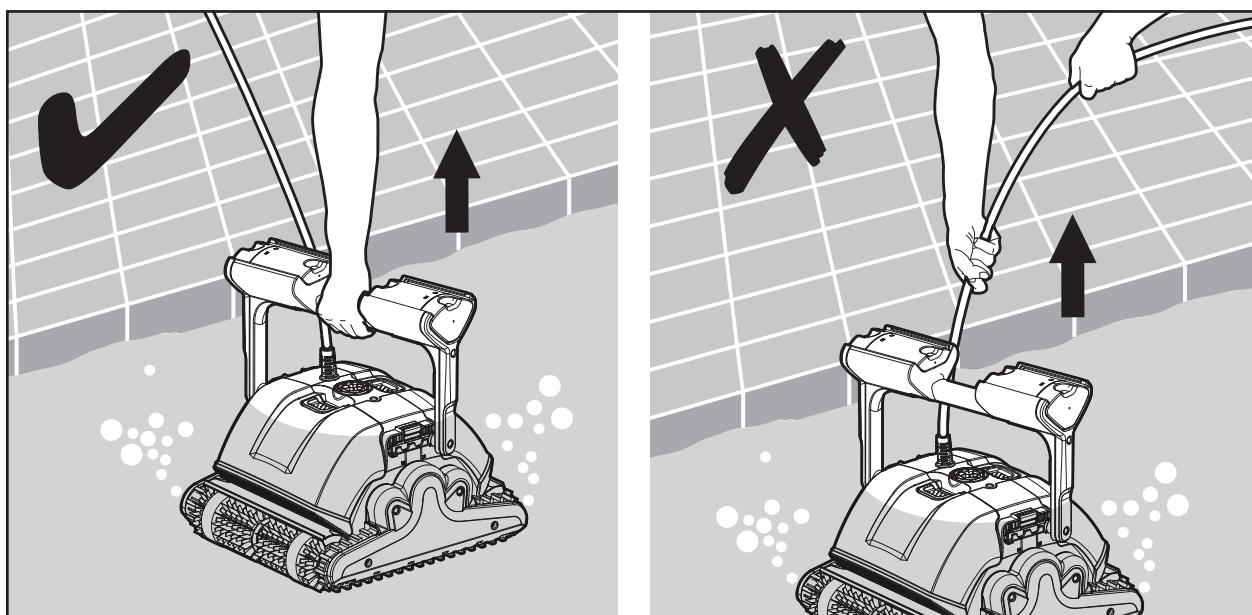
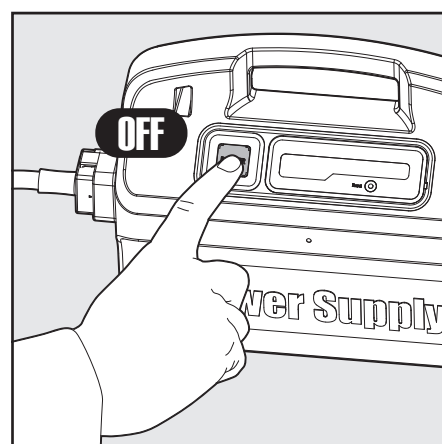

 DO NOT PULL THE POOL CLEANER FROM THE POOL USING THE CABLE.

6. ROUTINE MAINTENANCE

6.1 Cleaning the filters of the cartridges

 Unplug the power supply before any servicing activity.

Note: Do not let the filters of the cartridges dry out before cleaning.

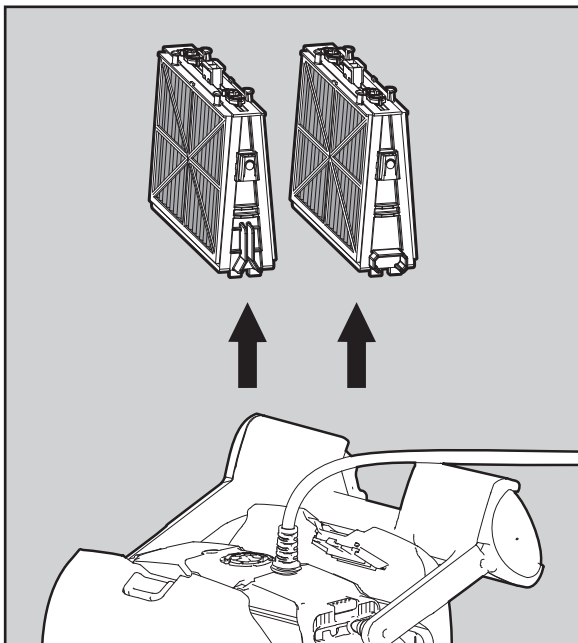

Open the filter covers and remove the cartridges from both sides of the robot.

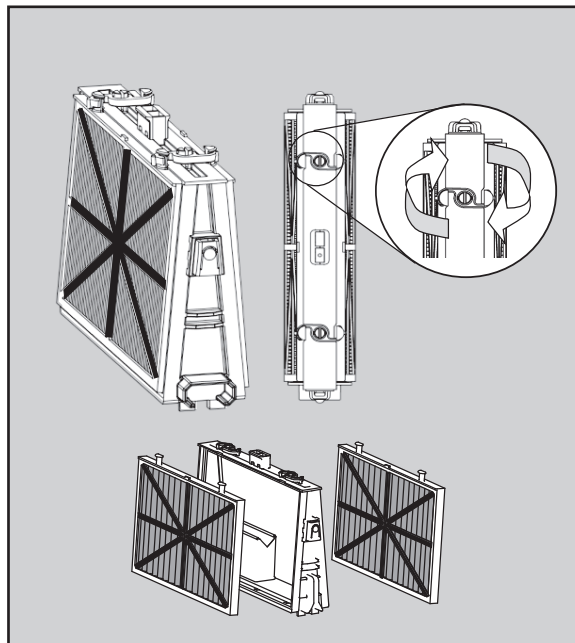

Open the clips and remove the filters.

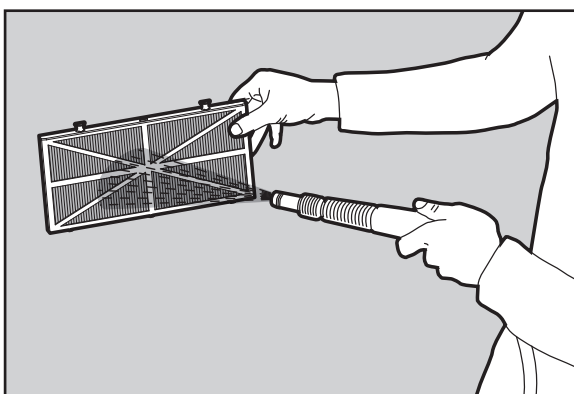

Clean the filters with a hose.

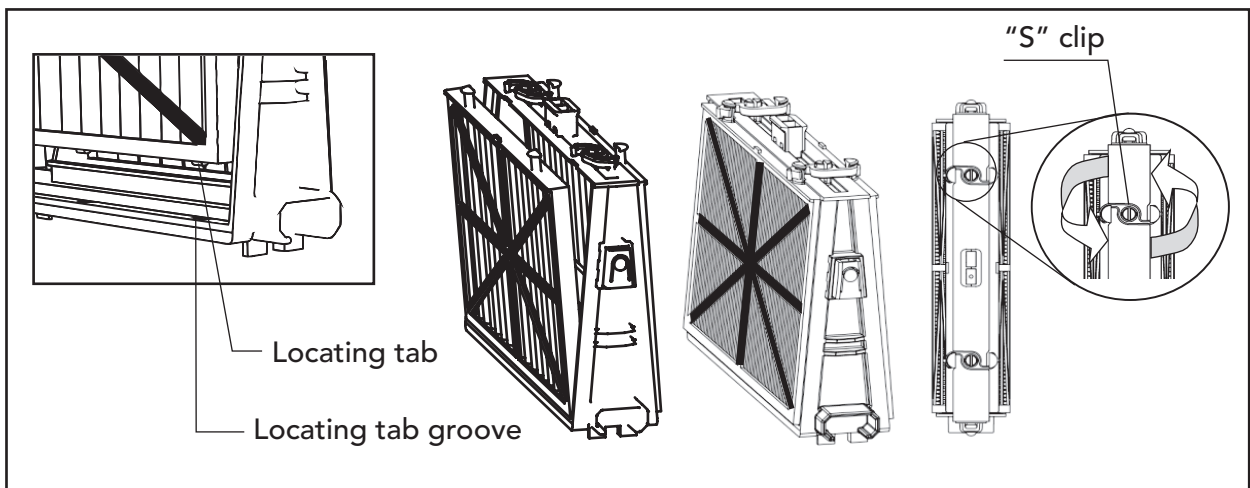

Reassembling the filter elements: Insert the locating tabs at the bottom of the filter element into their grooves on the base frame then close the "S" clip.

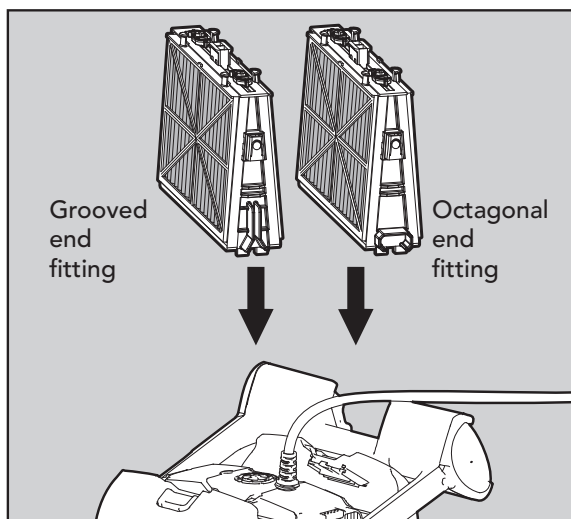

Reinstall the base frames with filters according to the diagram.

⚠ Do not force the filters into place.

6.2 Dismantling and cleaning the impeller

⚠ Unplug the power supply before cleaning.

Dismantle the impeller cover and clean around the impeller housing, then reassemble. (Use Phillips head screwdriver).

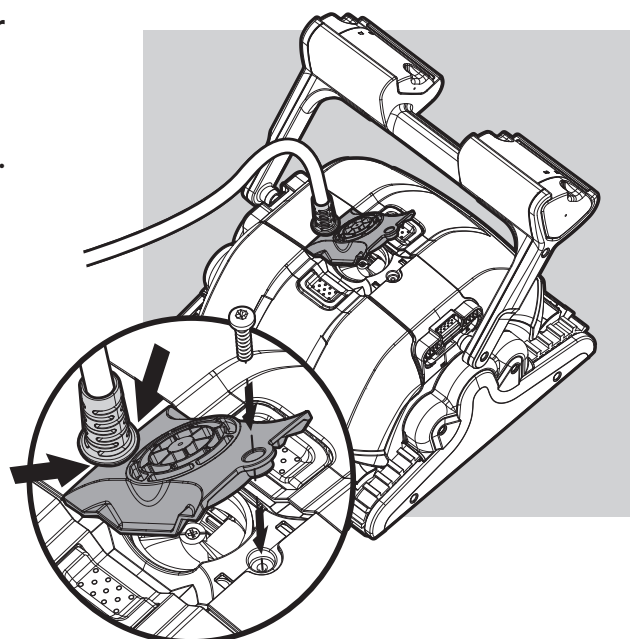

7. USING THE REMOTE CONTROL - M500 ONLY

The remote control unit offers two operation modes – automatic mode and manual direction control mode.

In automatic mode, the cleaning parameters can be changed.

In manual direction mode, the robot's motion can be controlled manually.

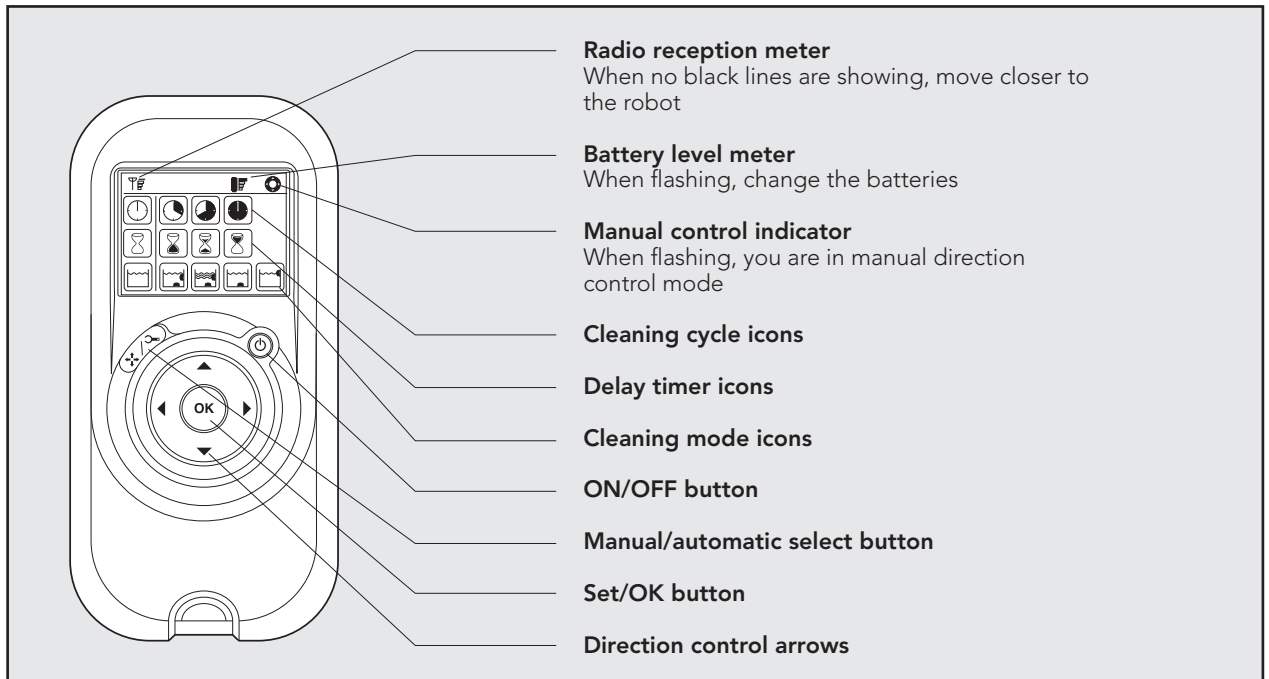

Manual Direction Control Mode

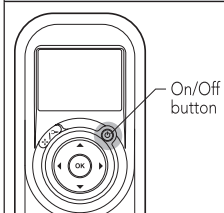

1. Press the On/Off button once. The remote control will start in manual direction control mode.
2. Use the direction control arrows (see right) to control the movement of the robot around the pool.

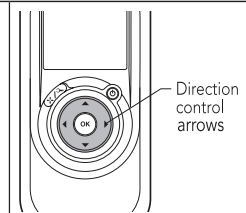

Exiting Manual Direction Control Mode and setting the Automatic Mode

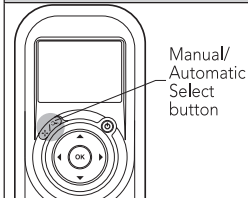



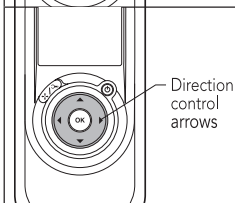
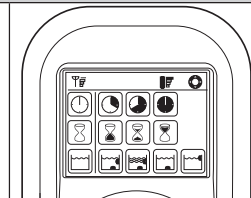



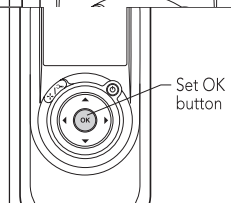





1. To exit the manual direction control mode, press the Manual/Automatic select button once only.
2. The digital screen will light up and three rows of function icons will be displayed in default mode.



1. To change the parameters press the up or down arrows.
2. To select the parameter settings use the right or left arrows. When you reach the required function press the Set/OK button.



Press the Manual/Automatic select button and then choose the desired parameters according to the following table:

 <p>Cleaning cycle indicator This determines the length of the cleaning cycle.</p>	 <p>Fast 1.5 hour cycle</p>	 <p>Efficient 2.5 hour cycle for everyday use. (Default setting)</p>	 <p>Extra 3.5 hour cycle</p>	
 <p>Delay time indicator This determines when the pool cleaner starts to work. Delaying allows the dirt to settle to the bottom of the pool.</p>	 <p>Immediate start (Default setting)</p>	 <p>One-hour delay</p>	 <p>Two-hour delay</p>	
 <p>Cleaning action indicator Allowing you to choose from the following options.</p>	 <p>Standard Floor and wall cleaning. (Default setting)</p>	 <p>Ultra-clean Stronger suction and slower movement. (floor and wall).</p>	 <p>Floor only Cleans only the floor and the area where the floor and walls meet.</p>	 <p>Walls only Cleans walls and waterline only.</p>

Note:

- After 2 minutes if no button is pressed, the remote control unit will shut-down and the Pool cleaner will continue to work in the previous settings.
- When the "Ultra-Clean" and "Walls Only" options finish their cycles, the Pool Cleaner will return to default settings.

8. OFF SEASON STORAGE

If the Pool Cleaner will not be in use for an extended period, perform the following storage steps:

- Make sure that no water is left in the Pool Cleaner
- Thoroughly clean the filters of the cartridges and insert in place
- Roll up the cable so that it has no kinks and place on the Caddy
- Store the pool cleaner upright on the Caddy in a protected area out of direct sun/rain/frost at a temperature of between 5°-45°C / 41°-113°F

9. TROUBLESHOOTING

Before contacting your Dolphin distributor please read through this guide.

Symptom	Solution
Cable twisting or cable coils up	Check for any obstruction in the pool
	Remove excess cable from the pool
	Make sure filter cartridge is clean
	Straighten cable and lay it in the sun periodically
Dolphin is moving in circles or does not reach all pool areas	Check for foreign objects in moving parts
	Make sure filter cartridge is clean and well mounted and that the filter doors are closed
	Make sure that there is enough cable laid out to cover the whole pool
	Before using the Dolphin at the beginning of the season you should brush any algae from the floor and walls of the pool
Dolphin is not traveling sideways on walls	Adjust the diagonal angle of the handle
Dolphin does not climb walls	Make sure the filter cartridge is clean
	If using the Dolphin at the beginning of the season, use the Net filters
	Check if brushes are suitable for pool coating and replace them if necessary
	Check if brushes are worn and replace them if necessary
	Make sure the impeller area is clean
	Check that the remote control is set for climbing - M500 only
Dolphin not sinking	Make sure the Wonder brushes or the combined brushes are soaked in water
Dolphin disengaging from wall at water line	If Dolphin climbs too high consult your Dolphin distributor
Remote control is not working - M500 only	Check if the batteries need replacing
Motor is not working	Check if the impeller is blocked
	Check if the drive system is blocked
	Electrical problem (power supply), check power source. If power source is in order, please contact your Dolphin distributor

Additional troubleshooting is available at our Website: www.maytronics.com