

**POOL-QUIP**

**POOLS**

**Big Six**

**ROUND POOL  
INSTRUCTION  
MANUAL**

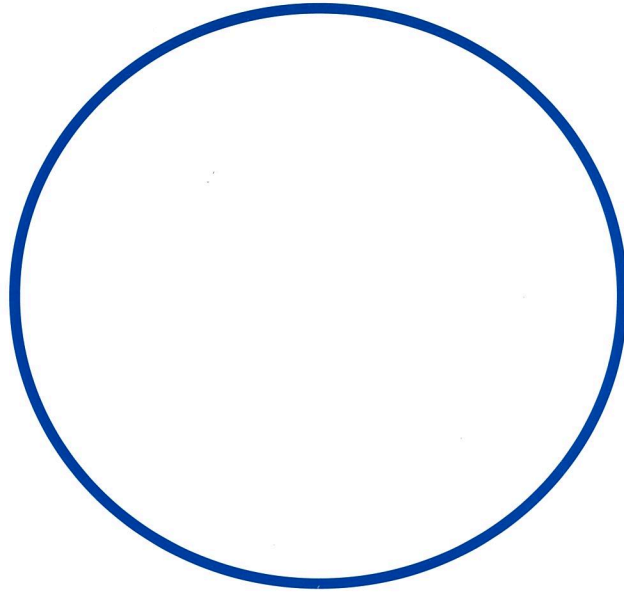

# Big Six

---

## A few important safety hints

- 1** Never leave a child to swim or even play around the pool unattended — even to answer the telephone.
- 2** Make sure that at least one person on hand knows rescue breathing, and basic first aid.
- 3** When planning the location of your pool please remember that some form of protection is vital. With sunken pools this should be some form of fencing, while the above-ground type should at least have an anchored cover. This will not only protect your own child, but also keep outsiders away, especially when you are absent.
- 4** Display emergency telephone numbers, safety and rescue breathing instructions for all to see, as well as basic life-saving equipment.
- 5** Have a responsible adult teach swimming and water safety.
- 6** Never leave non-swimmers alone with floating toys, or so-called inflatable swimming aids. Many of these have proven fatal. When buying — buy with safety in mind — think of any consequences first!

## Enjoy your swimming safely!



# INSTALLATION INSTRUCTIONS

The installation of your pool is a simple step-by-step procedure. To avoid delays and incorrect assembly, it is important to follow the instructions. If there is something you don't understand, please check before going ahead.

## ORDER OF POOL ERECTION

1. Check with your council regarding a permit.
2. Check the delivery of pool components — see that everything has been delivered. If there is something missing, get in touch with your supplier immediately.
3. Order sand, cement and earth for coving as required.
4. Mark out pool location.
5. Prepare site.
6. Set out the final pool dimensions
7. Assemble frames for pools.
8. Assemble pool ladder.
9. Deepen or dish pool centre if required.
10. Install wall — first decide on filter location.
11. Cut wall for surface skimmer or knock out plumbing.
12. Spread sand on base and prepare cove.
13. Install ground cover and bolt strip.
14. Install liner.
15. Check and secure liner.
16. Fit vertical supports.
17. Fit top rails, verticals and seats.
18. Fit plumbing for filter.
19. Fence Pool

MODEL No.	NOMINAL POOL SIZE	CAPACITY
1548	4.5 dia x 1.2m deep	18,000 LITRE
1748	5.4 dia x 1.2m deep	24,300 LITRE
2048	6.1 dia x 1.2m deep	28,800 LITRE

**PLEASE NOTE**  
SALT CHLORINATION SYSTEMS  
CANNOT BE USED ON PARAMOUNT  
POOLS.  
THE WARRANTY IS CANCELLED IF  
SALT SYSTEMS ARE INSTALLED.

**PLEASE NOTE**  
DO NOT SUPPORT DECKING OR  
PAVING ON THE TOP RAILING OF THE  
POOL.  
THE POOL MUST BE ABLE TO BE  
DISMANTLED AT ALL TIMES.

# Big Six

WHEN ORDERING SPARE PARTS  
PLEASE STATE ITEM NUMBER,  
DESCRIPTION AND PART  
NUMBER.

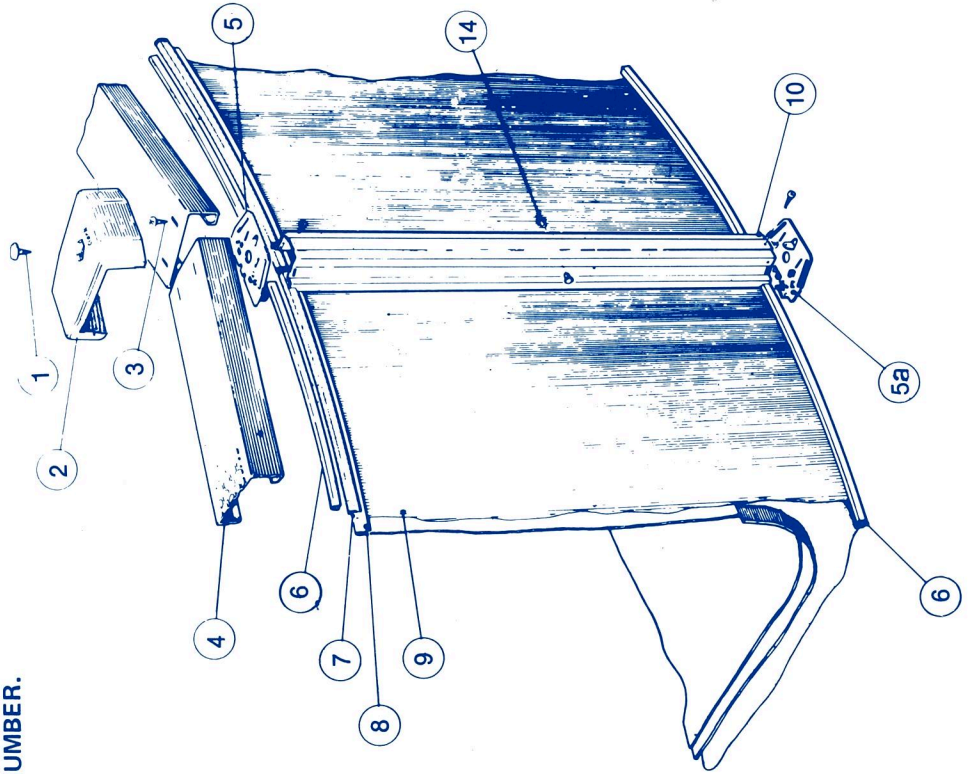



## 1. BUILDING PERMIT

Check with your local Council. A building permit may be required or it may be necessary to meet Drainage Board regulations. The Fire Department may also require notification. Most Councils know and understand the construction of our pools and are usually most helpful.

## 2. DELIVERY CHECK LIST (Please check items as soon as received)

	Big Six		Big Six	
	1548	1748	1748	2048
1 cover plate stainless screw	12	14	14	16
2 cover plate and cap	12	14	14	16
3 metal thread screw self tapping	72	84	84	96
4 seat	12	14	14	16
5 connector plate	24	28	28	32
5A strup connectors base channel				
6 rails small radius	24	28	28	32
7 coping strips	24	28	28	32
8 pool liner	1	1	1	1
9 pool wall	1	1	1	1
10 vertical support	12	14	14	16
11 plastic cover strip	1	1	1	1
12 wall nuts, bolts and washers	45	45	45	45
13 liner repair kit	1	1	1	1
14 grommets	24	28	28	32
15 diagonal brace				
16 base channel				
17 pressure plate				
18 skid member				
19 bolts (frame)				
20 skid member bolts				
21 nut				
22 washer				
23 spacer				
24 bolt (pressure plate)				
25 nut				
26 washer				
27 ground cover	1	1	1	1

## 3. ORDER SAND

When ordering sand check first to see that you have the required tools and aids for site preparation.

You will need a straight edge 100mm x 50mm x 320cm long; a carpenter's level; a line level; hammer; screwdriver; spanner; a 16 metre measuring tape; ball of string; a dozen stakes (about 30.5cm long); roll of adhesive tape; spade, tamping tool or roller; two pieces of hardboard approximately 60cm x 60cm; concrete slab for filter base.

MODEL	SIZE	SAND
1548	4.5 diameter	1.5 cubic metres
1748	5.4 diameter	2 cubic metres
2048	6.1 diameter	2.75 cubic metres

Before commencing your pool installation, check the following:—

### Pool Cartons

The table opposite shows how to select your pool parts. Select your pool size from the left hand column. The top line shows the size of pool numbers to make up your pool frame components. Follow the line on which your pool size is shown. The numbers indicate the number of parts of that identity.

Check for Liner. If package deal purchased, check also for: FILTER SYSTEM, LADDER, CHEMICALS AND ACCESSORIES, GROUND COVER. When opening the cartons check off the parts against the parts list. For filter components check the instruction sheet packed with the filter.

# Big Six

## 4. MARK OUT POOL LOCATION

In positioning pool, ensure that its location meets all Council By-Laws. Select a firm, level site free from stones, sticks, wire, roots and other sharp objects. Do not erect your pool on gravel, asphalt, tar paper or any oil based material, onion weed or any ground treated with weed killer (except Shell Hy or Var X). If ground has been treated with Shell Hy or Var X, leave two weeks before erecting pool.

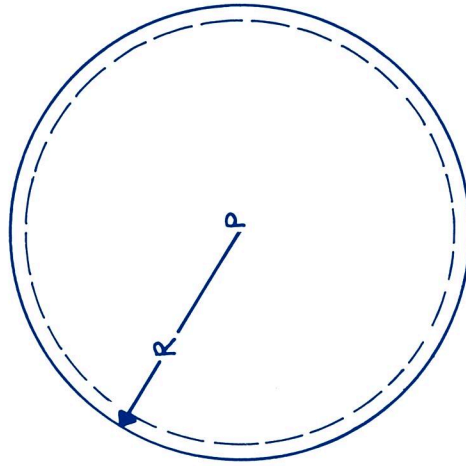

### ROUND POOL

From a peg at centre of site, extend string to slightly in excess of final radius and mark out approximate pool position.

IN PLANNING THE LOCATION OF YOUR POOL KEEP WATER SAFETY IN MIND, MAKE PROVISION FOR CHILD PROOF FENCING.

## 5. PREPARE AND LEVEL SITE

DO NOT BACK FILL LOW SIDE OF EXCAVATION

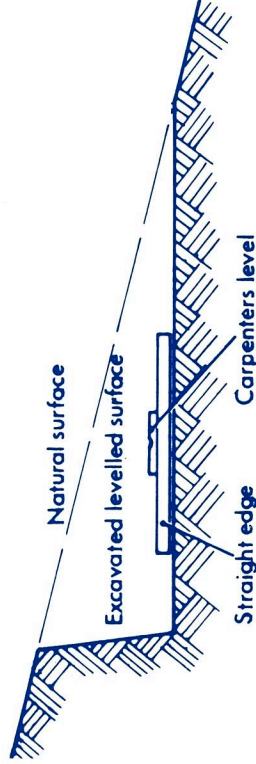

The ground on which your pool is to be erected must be firm and level within 25 mm. If on sloping ground, level out the high side — do not build up low side as the weight of pool water will cause movement.



## 6. SET OUT FINAL DIMENSIONS FOR POOL FRAME (ROUND)

Once the site is satisfactorily levelled, accurately remark the circumference of the pool. Using the centre peg, tie a marker (screwdriver) to one end of a string line and carefully scribe the required radius measurement per diagram. The final circumference should come within the previously levelled area. Place required amount of sand inside pool area.

1548

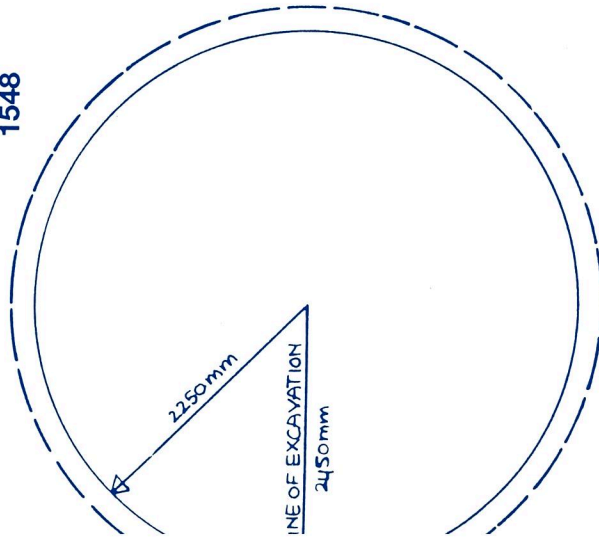

1748

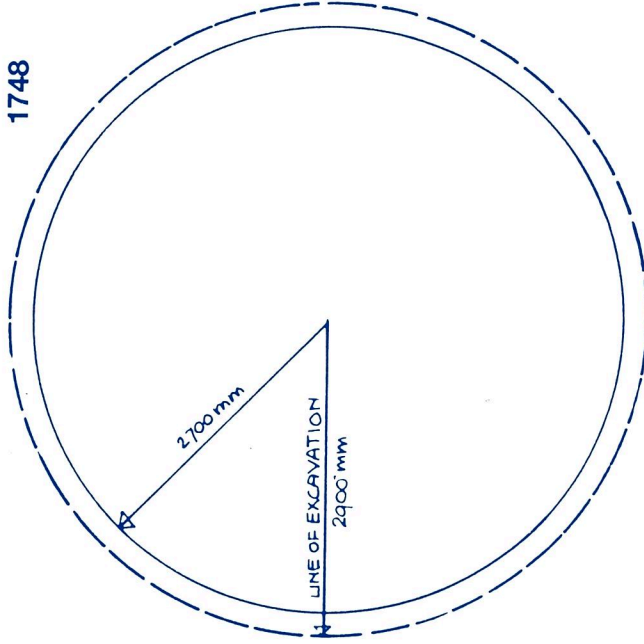

2048

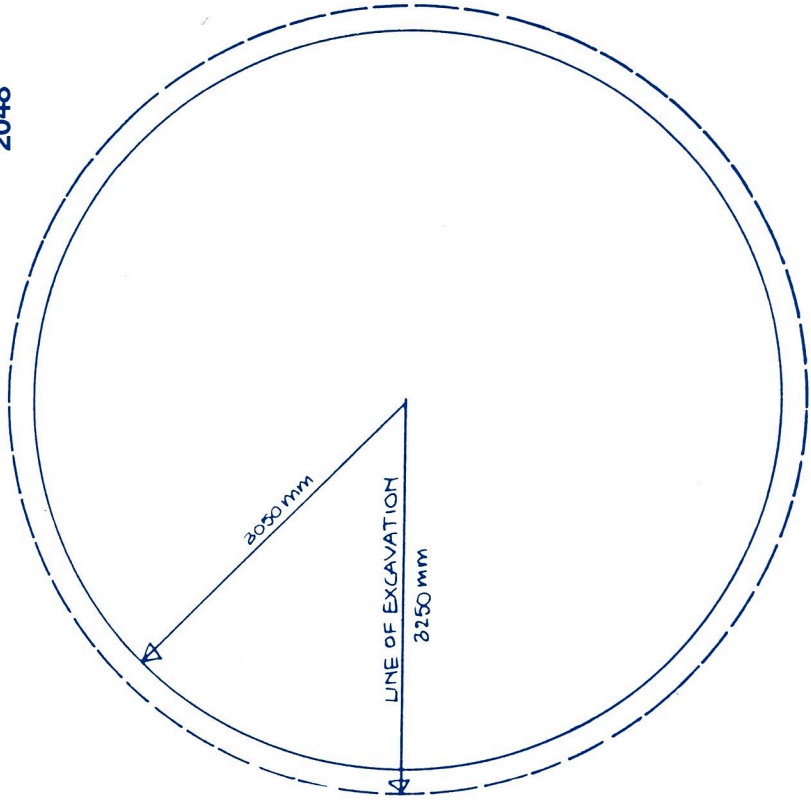

# Big Six

1 You will require the following items to successfully complete your installation.

## Tools

- Straight edge 100mm x 51mm x 3200mm long
- Carpenter's Level
- Hammer
- Screwdriver
- Small Side-cutters (Tin Snips)
- Rounded File
- 16m tape
- Ball of string
- 1 dozen stakes (about 300mm long)
- Roll adhesive tape
- Spade, Tamping Tool or Roller 600mm x 600mm
- x 50mm
- Concrete Slab (Filter Installation) if required
- 2 pieces Hardboard (approximately 600mm square)

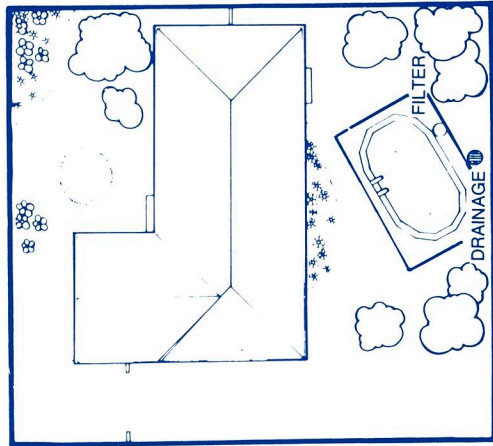
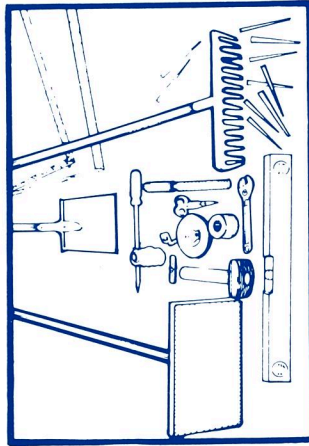

Shown opposite is a suggested site plan showing filter position, drain point and restricted access to pool from outside property boundaries.

## Preparation of Site

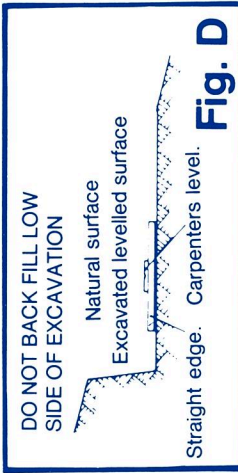
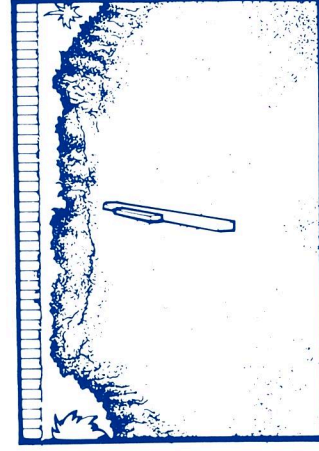
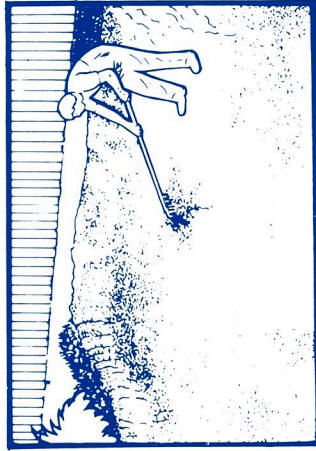

2 **Caution:** Do not erect your pool on gravel, asphalt, tar paper or any oil based materials. It is essential that all traces of hardy weeds be completely removed from under the pool as they may puncture the liner. Vegetation such as nut grass or onion weed must be poisoned with Methyl Bromide or similar potent weed killer before clearing the site. Be sure your pool area is free from stones, sticks, wire, roots and other sharp objects. Concrete is acceptable provided a bed of builders' fatty sand is used under liner.

**Note:** Under no circumstances is the low side of the selected site to be built up. The weight and movement of the pool water will ultimately pack down the filling, causing the pool to sink.

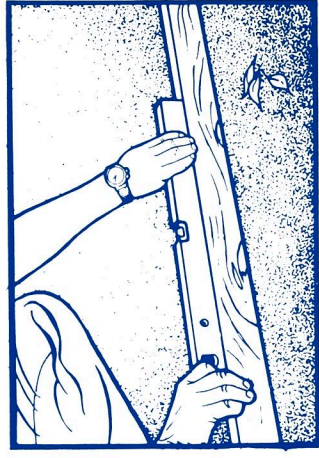
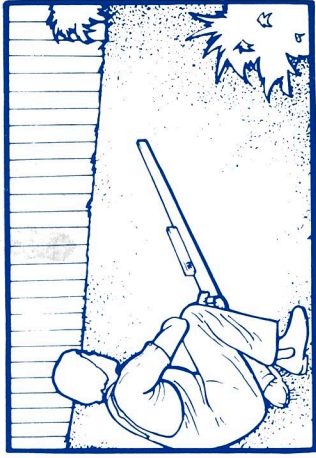

3 **Preparation of site**  
The ground upon which your pool is to be erected must be firm and level within 25mm. Mark out the required area (Fig. C). If necessary dig out the high side, check with carpenter's level and straight edge (Fig. D). The success of your installation depends entirely on how well the levelling is performed.



## 7 Sidewall Assembly

**Note:** During assembly take special care when handling the sidewall. Careless handling may result in a buckled wall. Two or three neighbours or friends would be a great help when erecting. Assembly on very windy days should be avoided.

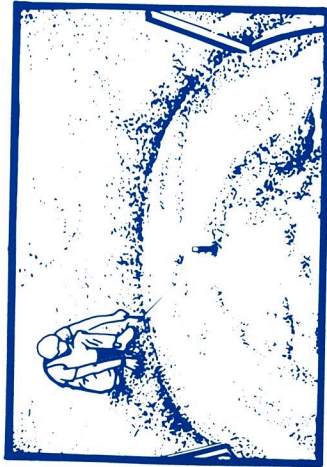

- 4 Tie a marker (screw driver) to one end of string line and from each peg scribe the required end radius measurement. This will be a guide for laying the base rail.

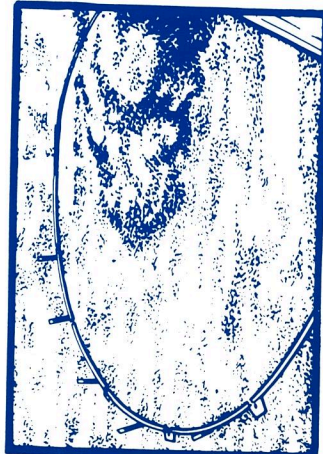

- 5 Slide the end rails into the connectors leaving approximately 32mm gap between them, and position with stakes so the rails conform to the radii marked out previously.

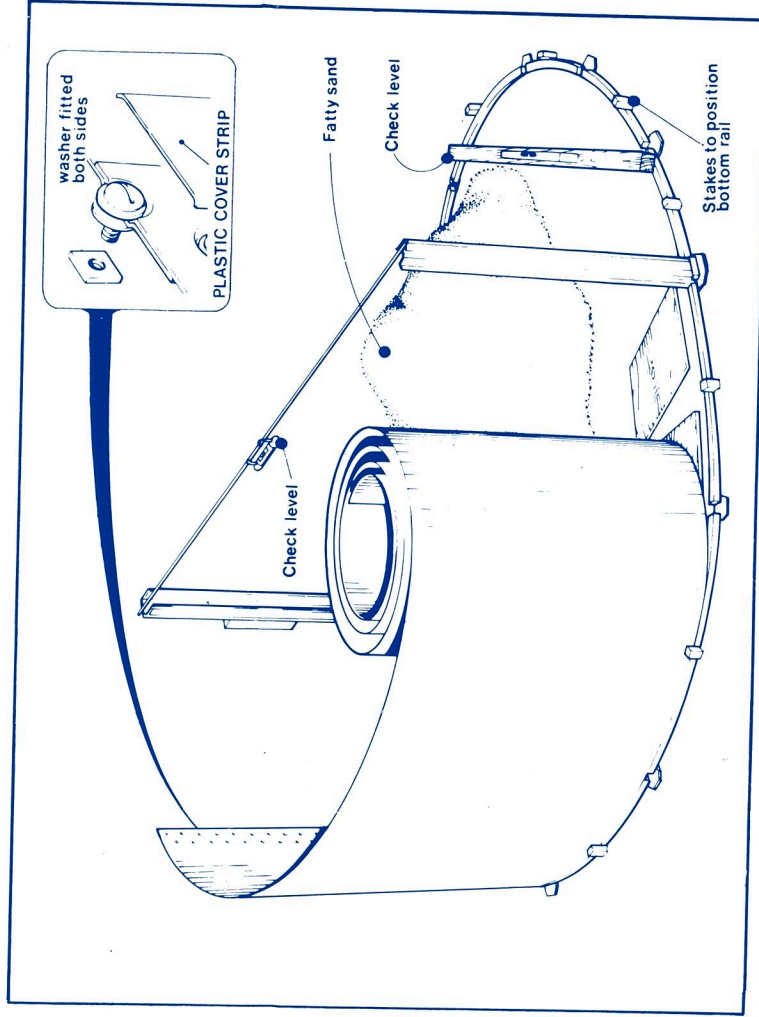

# Big Six

## 8. ASSEMBLE LADDER

1. Take the two ladder side rails with the 4 holes drilled, line up three ladder steps with the bottom three holes and bolt through the holes in the tube to securely fasten plastic ladder steps as in fig. 1.
2. Take the second set of ladder side rails and bolt a ladder step between the bottom two holes. This acts as a spacer only.
3. Take the ladder platform and bolt this to the two top holes in each ladder frame as completed in steps 1 and 2.
4. Slide the two top hoops on to the ladder frames. These are a firm fit, and will have to be eased on carefully to avoid damage to the tube. This completes the basic ladder frame, and all nuts and bolts should be firmly tightened.
5. Take the larger hoop that forms the lifting safety section of the ladder. Insert three ladder steps lining them up with the holes drilled in the frame and bolt into position. Place the plastic tips on the open ends of the tube.
6. Attach this section to the main ladder frame using the metal straps as in fig. 2. When assembled this section should swing up and lock in the up position. Tighten the hinge plates to stop side play, but do not over tighten.
7. When this ladder is fitted to the Big Six Pool there are lugs under the ladder platform that can be screwed to the pre-drilled seat (4) of the pool. For extra support an adaptor can be purchased.

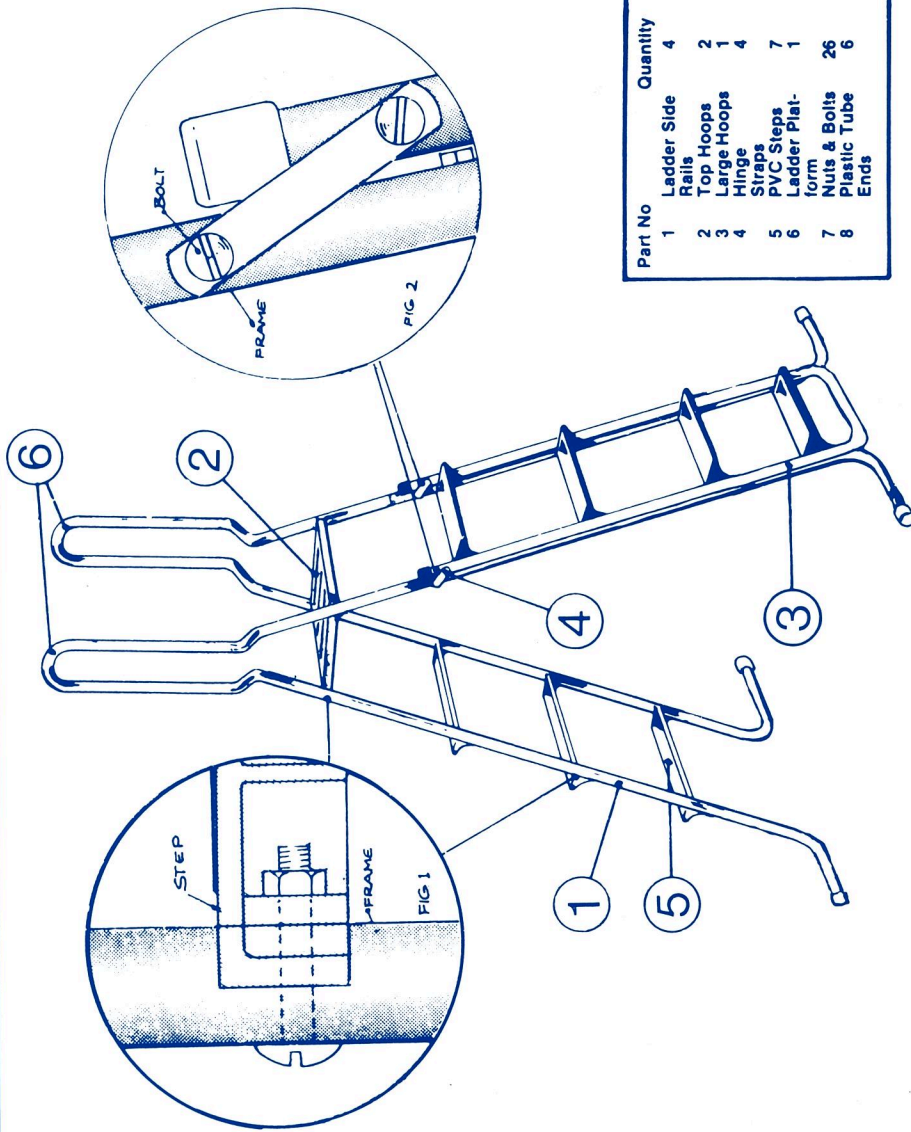

Part No	Quantity
1 Ladder Side Rails	4
2 Top Hoops	2
3 Large Hoops	4
4 Hinge	1
5 Straps	4
6 PVC Steps	7
7 Ladder Platform	1
8 Nuts & Bolts	26
Plastic Tube	6
Ends	

## 9. DEEPEN POOL CENTRE

Although the depth of your pool is designed to suit most family needs, greater depth can be had by excavating from the centre. It is most important that excavation is restricted to a maximum of 500 mm below the base level and that it is confined to the centre of the pool. If the excavation extends beyond recommended measurements, it could weaken the wall of the pool.

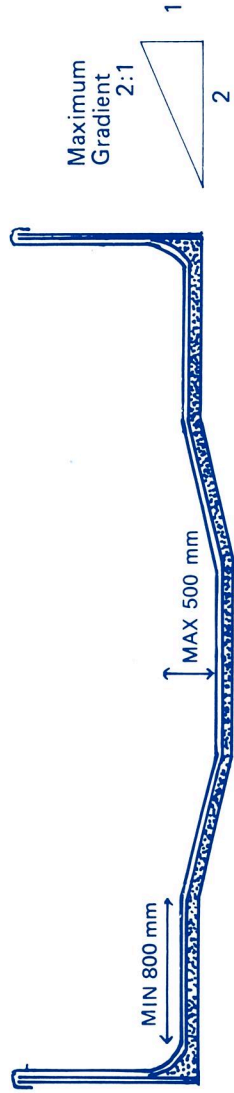



## 10 Install walls -first decide on filter location

- 6 Place the required amount of sand inside the pool area.

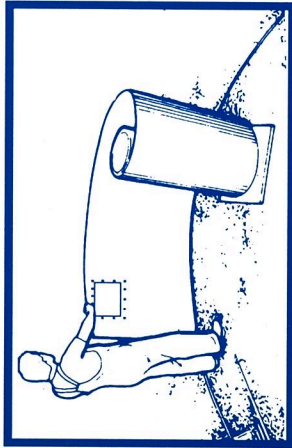

7-8 The Paramount pool wall is supplied with a pre-stamped, cut out section, sized for the Paramount SP1500 Surface Skimmer. It is positioned 600mm from the outside end of the coiled wall. Before installing the wall into the rails, ensure wall is correct way up and you are starting in the desired place.

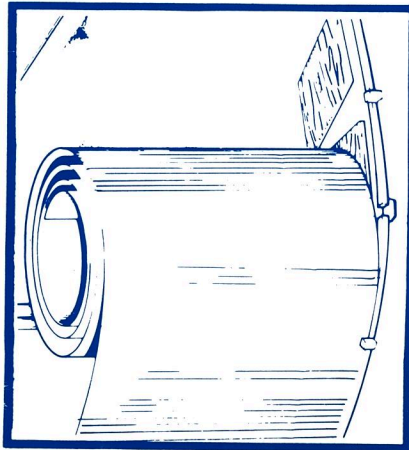

- 9 Use 2 pieces of hardboard, or similar, about 61cm square. One to stand the coiled wall on, the other to move it onto as you progress.

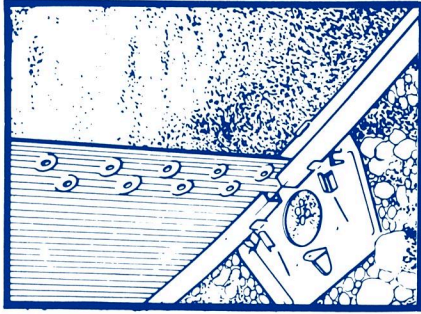

- 10 The join should be hidden behind a vertical support, start uncoiling the wall with the end directly over a connector thus covering join by a vertical. It is advisable to have someone hold the end of the wall to prevent it creeping along in the rail.



- 11 A few rails (3) may be placed on top of the wall to give rigidity whilst uncoiling. On reaching the end of the roll the bolt holes may not line up. This alignment is achieved by moving the rails in or out to suit.

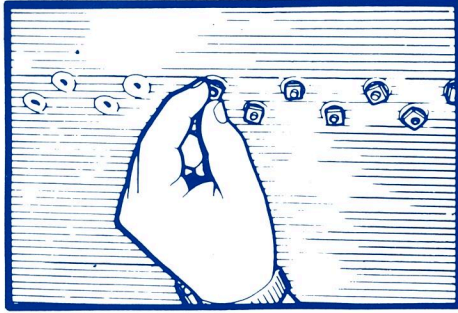

- 12 When the holes do line up, loosely assemble all the bolts, nuts and washers.

**Note:** It is important to fit a washer to each side of the wall and have the bolt head inside the pool. Firmly tighten all nuts.

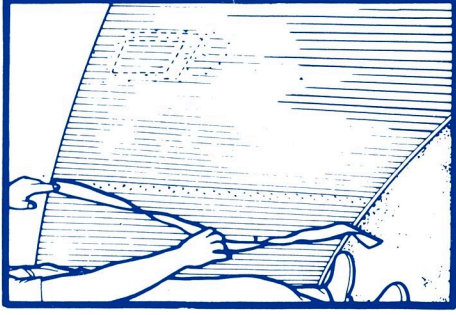

- 13 Cover the bolt heads with the plastic cover strip.

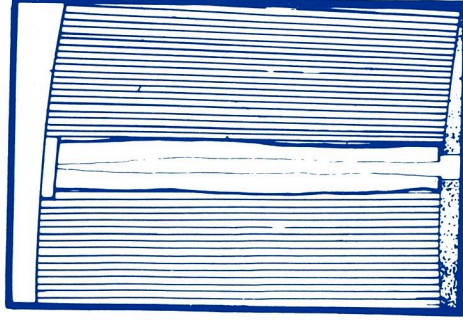

- 14 Tape it firmly into place starting from the bottom. Cut off 25mm from the top.



# Big Six

## 11 Cut wall for the plumbing of the eyeball returns

Although the pool wall is supplied with the surface skimmer section pre-punched, the eyeball holes are not cut.

This is to allow you to custom fit the eyeball returns (2) in the most suitable position.

**NOTE – It is essential that the cutting of the wall for these eyeballs is done at this stage of the pool wall installation, so all metal filings and off-cuts etc, cannot damage the pool liner.**

**Procedure –** Position the eyeballs where required.

– **Oval pools;** position both eyeball returns at the opposite end to the surface skimmer

– **Round pools;** position the eyeball returns approximately 120° and 240°, around from the surface skimmer.

It is recommended to fit the eyeballs at a distance of 200 to 300mm down from the top rail.

Cut a 48mm diameter hole for each eyeball with suitable small side-cutters (Tin Snips) or similar, remove all metal burrs and sharp edges with a round file, check hole sizing with actual eyeball before continuing.

**DO NOT INSTALL SURFACE SKIMMER OR EYEBALLS AT THIS STAGE.**

This is done at Step 18.

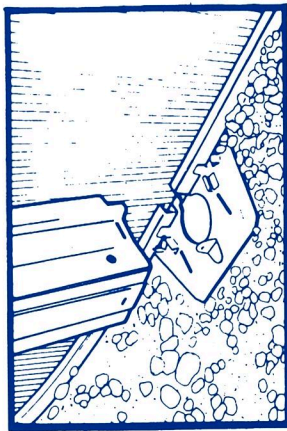
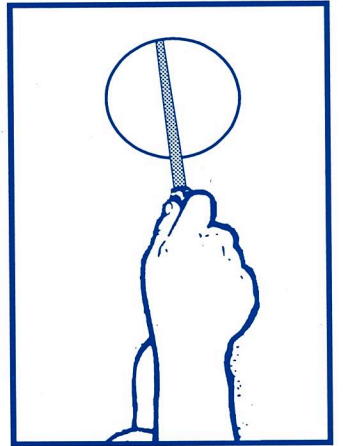

15 Ensure there is an even gap between the rail ends. Check radius.

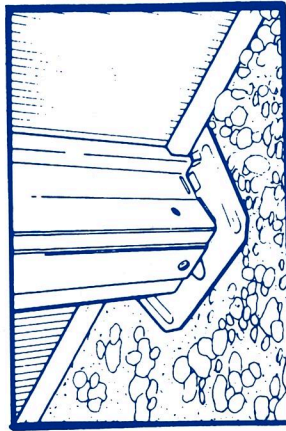

16 Install the verticals onto each bottom connector, bend connector tabs up, to hold verticals in position, and secure with self tapping screws.

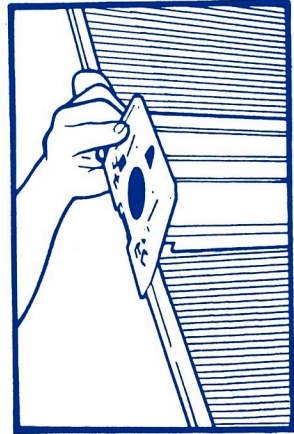

17 Temporarily hold wall and vertical together with top connector.  
**DO NOT BEND TABS DOWN AT THIS STAGE.**

## 12 Spread sand on base & prepare cover

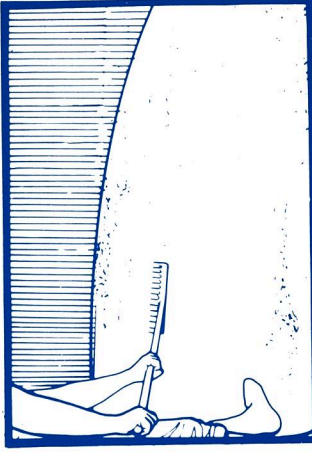
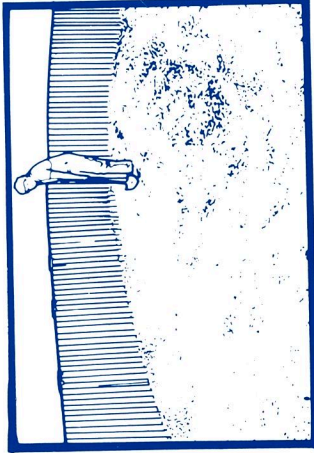

20 When seats are in position build up an even cover of soil around the wall of the pool approximately 150 mm and pack tightly.



18 **Pool preparation for liner**  
Remove the centre peg and stakes.

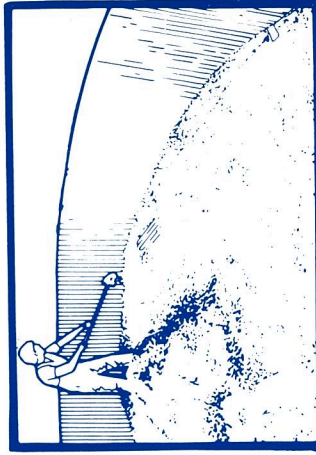

21 Spread the sand over the entire floor area to an even depth of approximately 50 mm.

19 **Note:** It is recommended that a trial installation of the seats be made before installing the liner and filling with water.



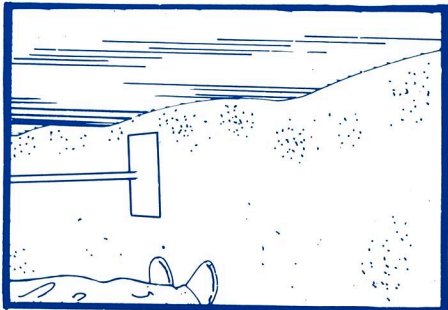

22 Compact the sand on the floor by tamping or rolling until a footprint no longer shows

### 13 Install ground cover & bolt strip

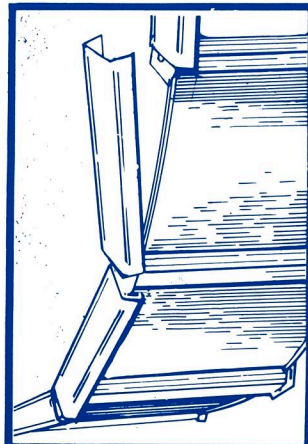

23 **Installation of liner**  
Remove all seats and connector plates.

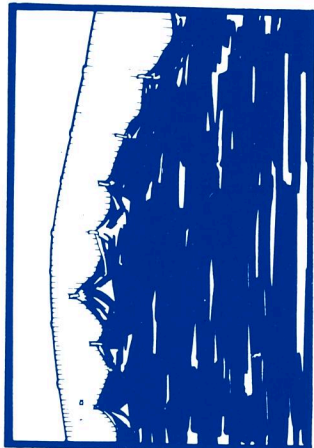

24 Place the pool pad (ground cover) over the entire floor area and hold it in position by taping it to the pool wall.

### 14 Install liner



25 Unroll the liner in the centre of the pool with the smooth side up. (The liner is easier to install if left unrolled in the sun to warm and soften).



26 Position the liner so that wall-floor seam is an equal distance from the wall, all around the pool.

### 15 Check & secure liner



27 Pull the liner wall up over the pool wall and hold in place with the plastic coping strips.

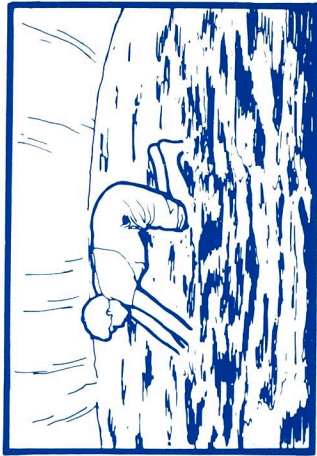

28 Commence running water into pool. When you have approximately 25 mm, remove all floor creases by working from the centre to the wall. Remember the more water over 25 mm depth, the more difficult it is to remove the creases.

### 16 Fit vertical supports

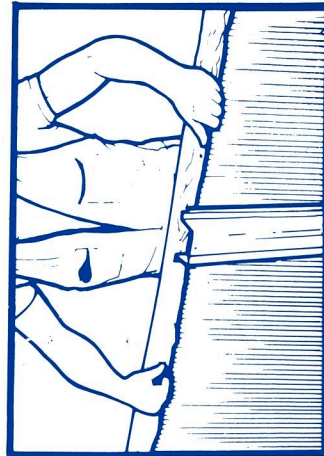

29 Continue to run water and adjust liner tension on the wall by removing coping one at a time. Remove all creases from liner wall and continue to fill to approximately 61 cm deep. Install the liner over wall as shown above.



# Big Six

## 17 Fit top rails, verticals & seats

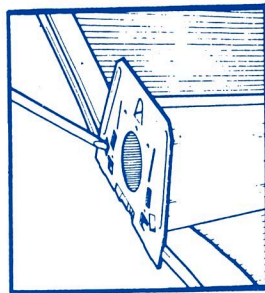

- 30 Install top rails and connector plates. Bend down connector tabs and secure with self tapping screws. Refer to Weir Skimmer and Filter instructions for installation of same.

## Seat Assembly

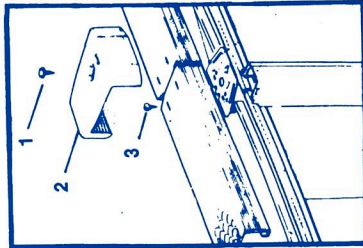

- 31 Install seats with approximately 60cm of water in pool.

## 18 Fit Surface Skimmer and Eyeball Returns

Do not install these items until the water level has filled to just below the cut out positions in the wall.  
This will ensure the liner is cut with accuracy and lines up easily to the metal cut-outs, reducing chances of unsightly wrinkles around these fittings.

**Procedure – Paramount SP1500 Surface Skimmer**

Hold the face plate in position through the cut out, pierce the liner through the 15 bolt holes (1) with a pointed spike to allow easy insertion of the bolts.

Place one gasket on the inside of the face plate and carefully insert bolts through, starting with the four corners.

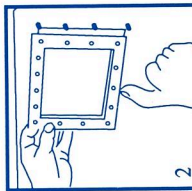
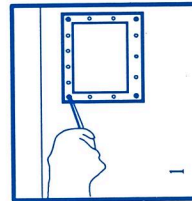

Place 2nd gasket (2) on outside of the wall and then position actual skimmer box on the protruding bolts. Ensure both gaskets have seated properly, fit nuts to bolts and tighten **all 15 evenly**.

Finally trim the liner around inside of the skimmer mouth, check skimmer basket is locked and position deck lid.

### EYEBALLS

Cut the liner to the hole size in the wall. Ensure you cut it the same size or slightly smaller, **but not larger**.

Fit a gasket to the eyeball, then position eyeball through the liner, then wall. Thread lock nut on and tighten.

Proceed with the connecting of the plumbing. Do not cover pipes until you have run water through the entire filtration system, checking all joins for leaks.

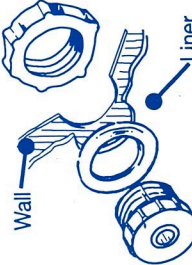

## Maintenance

**Pool Liners: DO NOT DRAIN THE POOL**  
Leave the pool filled throughout the year, suitably protected by winterising programme (see Chemical Treatment Brochure). Unless the liner has been damaged and cannot be repaired in situ, draining the pool unnecessarily could result in excess liner shrinkage which is not covered under warranty. If the liner has been damaged repairs should be carried out preferably with the liner in place and removed only if replacement is necessary. If a liner is to be returned under warranty, please contact your local store prior to shipment. Returned liners must be thoroughly cleaned and dried inside and out. Mark the damaged area with a black grease pencil. The liner should be folded neatly and packed securely into a cardboard box marked with return Name and Address. The pool can be drained by using the vacuum and diverting the return line, or by siphoning.

**Replacement Parts:** Replacement parts can be ordered from your local Store. Include the pool size, part name and number when ordering.

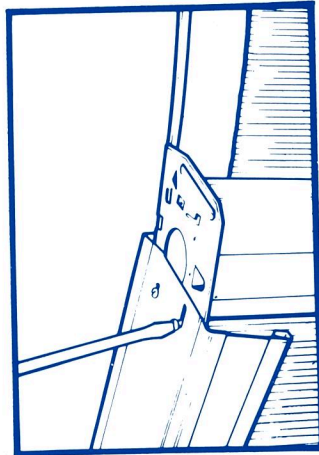

- 32 Fit all sets to connector plates with self tapping screws loosely, at first. Adjust their fit (alignment and spacing) and tighten screws firmly.

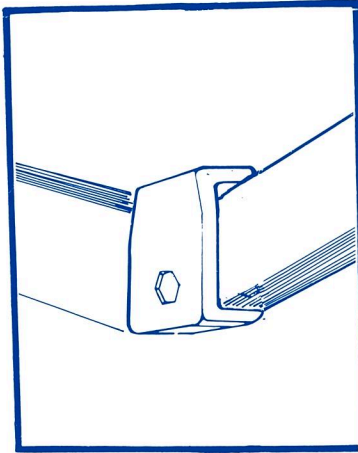

- 33 Attach the cover plate (2) as shown and secure with Stainless steel screw (1) and fit cover cap.  
Press plastic grommets (14) into holes in verticals around pool ends. Continue to fill pool to approximately 100mm from top.

**Important:** Refer to the Pool Chemical Treatment Brochure before using your Swimming Pool or Filter.



# 19 FENCE YOUR POOL

Extract from "Guide to Swimming Pool Protection" published by N.Z. Water Safety Council.

## FENCING

Fences are the most permanent form of physical protection for swimming pools. Because they form a fixed barrier between the pool and its surroundings, they protect all ages, especially the very young. The most effective means of protecting children from drowning in swimming pools is to fence the pool area itself rather than the whole property.

As the majority of children are drowned in their parents' pools, a fence which surrounds the whole property only protects other children in the neighbourhood.

Many children drown while playing near the pool rather than using it, so it is important that playing areas are located outside the fence.

## SEPARATION OF FENCE FROM THE POOL

Ideally, a fence should not be less than 1.20 m (4 ft) from the waterline of the pool. If a child managed to climb the fence, this distance would prevent her from falling directly into the pool. It would also prevent older children jumping off the fence into the pool and would ensure enough room for rescue operations should the need arise.

## LOCATION OF THE FENCE

When choosing the location of a fence it is important to make sure that objects such as trees with overhanging branches or buildings with balconies are not close. Children can quite easily fall from these into the pool or pool area. It is also important not to leave step ladders or sun-deck chairs near the outside of the fence as this can be used as climbing aids.

## TIME OF ERECTION OF FENCE

The fence should be built prior to the building of the pool or as soon as possible after the pool is filled.

## HEIGHT

Fences and gates should be at least 1.2 metres (4 ft) high on the outside at any point along their length. They should also allow for space between buildings, trees, terraces, etc.

## GROUND CLEARANCE

The gap between the bottom of the fence and the ground should be less than 100 mm (4 in.).

## OUTSIDE SURFACE

The outside surface of all fences should be smooth so children cannot climb them.

## HORIZONTAL LENGTHS

All horizontal lengths, such as rails, rods, wires or bracings that could be used as holds for climbing must be placed on the inside of the fence. They should be spaced at least 900 mm (3 ft) apart.

## UPRIGHTS

There should not be more than 100 mm (4 in.) between any uprights, such as palings, rods or wires.

## GATES AND FITTINGS

Gates should meet the following additional requirements.

## Mounting of Gates

Gates should be mounted so that:

- (a) They only open outwards;
- (b) They are free from any obstruction which could hold them open;
- (c) When pushed inwards or lifted upwards the movement does not release the latching device, unhinge the gate or leave a gap wider than 100 mm (4 in.).

## Latching Device

- (a) Gates should be fitted with an automatic self-latching device which can only be released manually;
- (b) The latching device should not be within a child's reach from the outside, but within easy reach from the inside;
- (c) Both the latching device and fence should be able to hold the gate closed.

## Automatic Closing Device

All gates should be fitted with a device which will automatically close them.

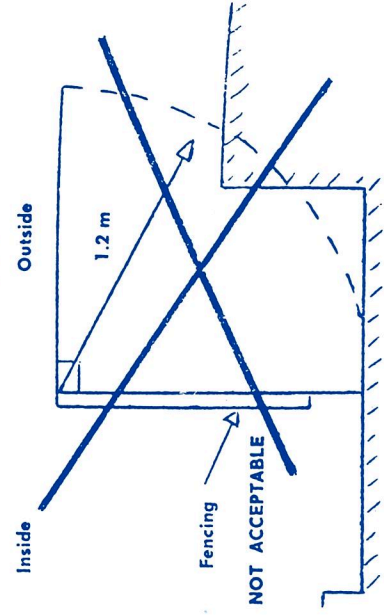
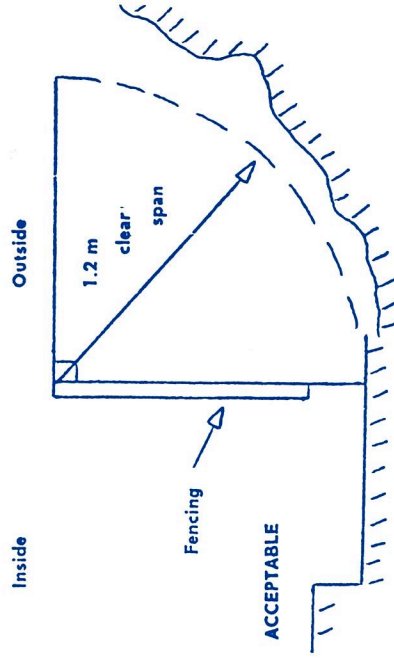

# Big Six

## Specifications for Fences and Gates

The following specifications have allowed the consumer a great deal of flexibility in choice of fencing, desirable aesthetics and cost.

## DESIGN AND CONSTRUCTION

Fences and gates should be designed and built so that at any point they prevent small children from climbing under, over or through them.

## MATERIALS

The materials used should be highly resistant to the effects of weather, sunlight, pool chemicals and water.

## Examples of Pool Fencing

Because there is a wide range of fencing materials available and a variety of ways in which they can be assembled it would be impossible to cover all technical specifications of fencing.

This information is intended therefore to serve as a broad guide to some of the main construction standards that the more common types of fencing should meet.

### (a) Post and Rail Construction

Fences built of palings or corrugated iron, corrugated asbestos, corrugated aluminium or similar profiled wall material would be suitable, provided that the rails are located on the inside of the fencing. Paling fences would be suitable, provided that the palings are spaced not more than 100 mm (4 in.) apart, with the horizontal rails no less than 900 mm (3 ft) apart.

### (b) Chain Wire Mesh Fences

Chain wire mesh fences are suitable, provided that the mesh openings are not more than 25 mm (1 in.). The mesh must be firmly fixed and tightly strung with the openings arranged in a diamond pattern.

### (c) Fabricated Metal Fences

Fences made from small section steel, aluminium or a similar metal are suitable provided that the uprights are not spaced more than 100 mm (4 in.) apart.

### (d) Infill Panel Fences

Fences made of glass fibre, reinforced glass, timber ply or similar sheeting built in framed ledges or panels would be suitable. Horizontal holds should be at least 900 mm (3 ft) apart and any openings should be less than 100 mm (4 in.). It is important that the sheet metal is rigid and securely fixed to its frame.

### (e) Brickwork or Masonry Fences

Fences made of bricks, blocks or masonry would be suitable. Any bricks set in or out of the fence more than 50 mm (2 in.) in depth or width, or any openings in the fence, should be at least 900 mm (3 ft) apart. The openings in any type of hollow ornamental brick should not be more than 25 mm (1 in.).

Manufactured by

**POOL-QUIP**

390c Church Street, Penrose. PO Box 12-840, Penrose, Auckland, NZ  
Telephone 64-9-525 3210 Facsimile 64-9-525 1020