

AQUAMASTER

Installation and Operation Manual



OFFICES - AUSTRALIA

NSW - Sydney
(HEAD OFFICE)
Tel : +61 2 9898 8686
VIC/ TAS - Melbourne
Tel : +61 3 9764 1211
WA - Perth
Tel : +61 8 9273 1900
QLD - Brisbane
Tel : +61 7 3299 9900
SA/ NT - Adelaide
Tel : +61 8 8244 6000
ACT Distributor
Tel : +61 2 6280 6476

OFFICES - OVERSEAS

Waterco USA
Augusta, USA
Tel : +1 706 793 7291
Waterco Canada
Longueuil, Qc, Canada
Tel : +1 450 748 1421
Waterco (Europe) Limited
Sittingbourne, Kent. UK
Tel : +44(0) 1795 521 733
Waterco France
SAINT PRIEST, France
Tel : +33 (0)4 72 79 33 30
Waterco (NZ) Limited
Auckland, New Zealand
Tel : +64 9 525 7570

Waterco (C) Limited
Guangzhou, China
Tel : +8620 3222 2180

Waterco (Far East) Sdn. Bhd.
Selangor, Malaysia
Tel : +60 3 6145 6000

PT Waterco Indonesia
Jakarta, Indonesia
Tel : +62 21 4585 1481

Waterco International Pte Ltd
Singapore
Tel : +65 6344 2378

WARNING

This equipment must be installed and serviced by a qualified technician. Improper installation can create electrical hazards which could result in property damage, serious injury or death. Improper installation will void the warranty.



Notice to Installer

This manual contains important information about the installation, operation and safe use of this product. Once the product has been installed this manual must be given to the owner/operator of this equipment.

WATERCO

Waterco Limited ABN 62 002 070 733

Member
WATER
QUALITY
ASSOCIATION



WATERCO

water, the liquid of life

www.waterco.com

Table of Contents

Introduction

What is included in the package?

Hydraulics	03
Hydraulic Layout	03
Installing Equipment	05
Aquamaster Control enclosure	05
LCD Control Screen.....	05
Temperature Sensors	06
Valve Actuators (Optional)	08
Flocheck Valve	09
Electricals	11
System Earthing	12
Input power wiring	12
System Start-up and Testing	20
Configuration	21
Operation	30
Warranty	40
Glossary	44

IMPORTANT SAFETY INSTRUCTIONS

When using this electrical equipment, basic safety precautions should always be followed, including the following:

READ AND FOLLOW ALL INSTRUCTIONS

- **! WARNING:** Disconnect all AC power during installation.
- **! WARNING:** In order to avoid the possibility of hyperthermia (heat stress) occurring it is recommended that the average temperature of the spa - pool water does not exceed 40°C.
- **! WARNING:** Aquamaster is not intended for use by persons (including children) with reduced physical sensory or mental capabilities, or lack of experience and knowledge, unless they have been provided supervision or instruction concerning use of the appliance by a person responsible for their safety. Children should be supervised to ensure they do not play with the appliance.
- In certain situations unexpected start up may occur when the appliance is in automatic mode. The installer should assess the risk associated with unexpected start up of any connected device which, in any circumstance should have no hazardous effect.
- Aquamaster is not meant to provide safety protection for connected devices. All connected devices should have their own protection for safe operation.
- Aquamaster should be deactivated if the pool or spa has been drained.
- Aquamaster Pool and Spa Automation products operate with 240 volts and must be installed by a suitably qualified person in accordance with current Australian Standards, the Australian Wiring Rules (AS3000) and local statutory authority regulations.
- Parts containing live parts, except parts supplied with safety extra-low voltage not exceeding 12V, must be inaccessible to a person in the spa – pool.
- Parts incorporating electrical components, except remote control devices, must be located or fixed so that they cannot fall into the spa – pool.
- The appliance should be supplied through a residual current device (RCD) having a rated residual operating current not exceeding 30mA.
- A green coloured terminal marked “Earth” is located inside the wiring compartment. To reduce the risk of electric shock, this terminal must be connected to the grounding means provided in the electric supply service panel with a continuous copper wire as sized to comply with current Standards and local statutory authorities in relation to the circuit conductors supplying the equipment.
- A cable connector is provided on this unit to connect a suitably sized copper conductor between this unit and any metal equipment, metal enclosures of electrical equipment, metal water pipe, or conduit within 1.5m of the unit via equipotential bonding.
- **SAVE THESE INSTRUCTIONS.**

INTRODUCTION

Thank you for choosing Aquamaster Pool and Spa Automation which provides you with a full range of automation features. While you focus on fun, Aquamaster allows you to automate pool, spa, and ancillary backyard functions like:-

- Pump
- Filter
- Heater
- Cleaner
- Pool / spa landscape lighting
- Water features

What's included in the Package?

- Aquamaster Control Enclosure
- 1 x LCD Control Panel
- 2 x pool and air temperature sensors 3 metre
- 1 x roof temperature sensor 25 metre
- 1 x Control Cable RJ12 x 3 metres

Essential Accessories

- 1 x Flocheck valve

Optional Accessories

- Additional LCD Control Panel sold separately
- FPI actuator sold separately
- Waterco ECO Pump sold separately
- Waterco ECO Pump motor control cable sold separately

HYDRAULICS

a. Hydraulics Layout

Pool/Spa configuration

These systems use a single filter pump and filter. Pool or spa operation is controlled by two 3-way valves (suction and return). In Pool/Spa Configuration, select: Pool/Spa Setup

Pool and Spa

- i. The Aquamaster can be programmed to accommodate spa spillover, if desired.
- ii. A conventional heater (gas or heat pump) and solar can be used to heat both the pool and the spa.
- iii. If a chlorinator cell is plumbed prior to the pool/spa return valve, then both the pool and the spa may be chlorinated.
- iv. The pool water temperature sensor should be installed prior to any heater or solar and will display either the pool or the spa temperature, depending on the current operation of the pool.
- v. Note:- The temperature will only be displayed when the filter pump is running.
- vi. If any water feature or pressure side cleaner boost pumps are used, be sure to enable the “interlock” feature to ensure that the pumps operate only when the filter pump is on and the system is in the “pool only” operating mode. The interlock feature ensures the filtration pump is operating prior to allowing another system component to operate.
- vii. The plumbing diagram below is intended to be used as a general guideline and is not a complete plumbing schematic for the pool.
- viii. We recommend the air sensor be installed for user convenience and for the freeze protection feature for the filter, valves or aux outputs.

Hydraulics diagram

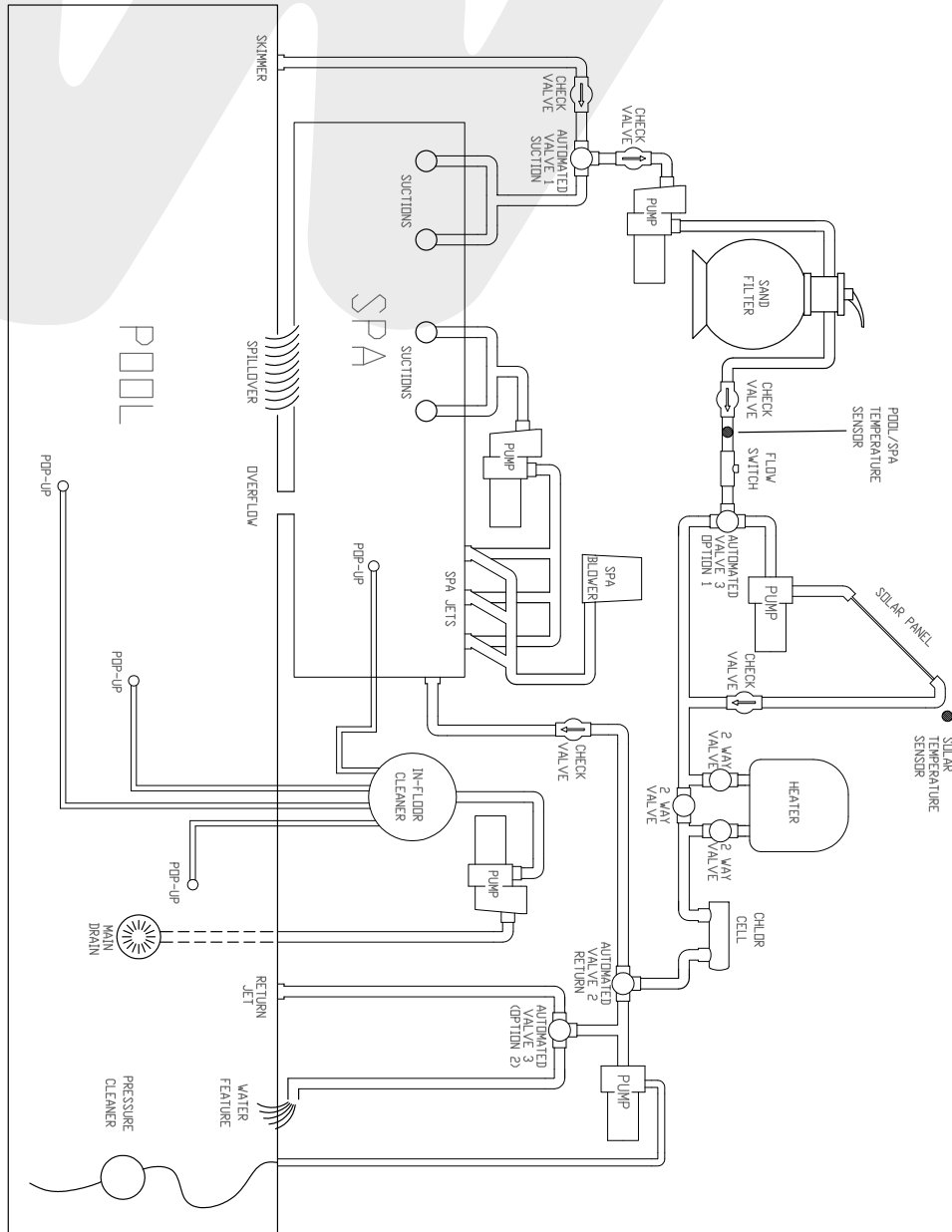

INSTALLING EQUIPMENT

a. Aquamaster Control Enclosure

Install the Aquamaster control enclosure in a protected location out of direct sunlight. At top rear of the control panel locate two keyhole fixing points. Mount two pan head type screws at 216mm centres using a spirit level on an adequately stable vertical surface. Align the screw heads with the keyhole fixing points and allow the enclosure to slide down on the screws.

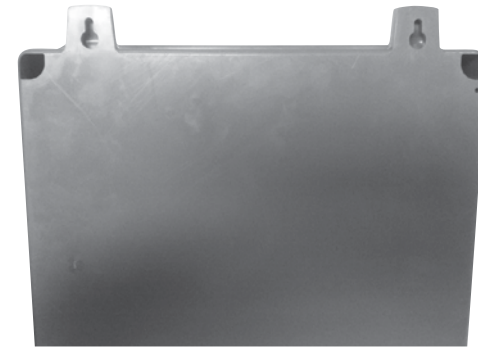

To access the Aquamaster for connection of cabling and sensors locate the front panel of Aquamaster and screw well in each corner. To open the panel, insert a flat blade screw driver and half turn anti-clock wise to release the spring loaded locking pin. Ensure the pins are fully released prior to opening the hinged front panel.

b. LCD Control Panel

Indoor Installation

The LCD Control Panel is suitable for indoor mounting. The back plate of the LCD Control Panel is removable and is easily mounted utilising methods similar to installing a standard Australian wall switch plate with mounting centers of 76mm.



Outdoor Installation

The LCD Panel is able to be mounted outdoors within a suitably rated weatherproof enclosure.

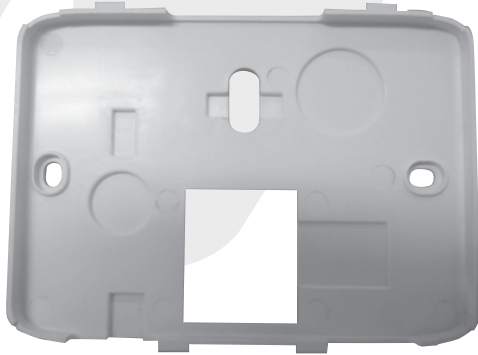

c. Temperature Sensors

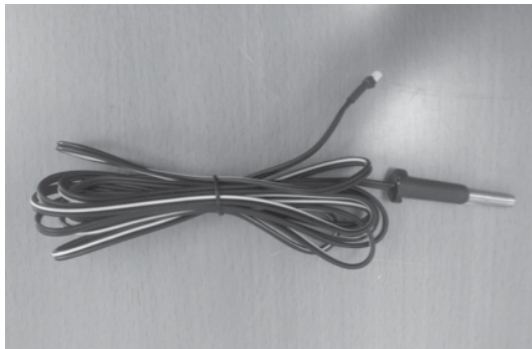

The Aquamaster has a number of sensors for pool, roof and air temperature monitoring.

Pool Sensor:

- The pool water temperature sensor should be installed prior to any heater or solar and will display either the pool or the spa temperature, depending on the current operation of the pool.
- Immediately after the filter drill a 9.5mm hole in the side of the line as shown in the image below. Insert the special plug into the hole and rotate home.

- Insert the sensor holder by pushing into the plug fully up to the head. This is a tight fit to ensure sealing. Lubricate with soap if necessary but do not use mineral oil or grease.
- Strap lead firmly to pipe to prevent any strain on the sensor holder or lead entry.
- The sensor should not be installed on top of any pipe work coming from the pump as it is exposed to sunlight and accidental physical damage may occur. It should be installed on an inside elbow of the pipe work (as shown). This will eliminate heating of the sensor by sunlight – giving inaccurate readings, and also minimise the risk of damaging the sensor by pool users.
- Where the pool is fitted with an integrated with filtration heater and independently plumbed solar system the pool probe must be installed in the filtration hydraulic circuit.

Note:- during system setup the independently plumbed solar system must be programmed as integrated to achieve full functionality.

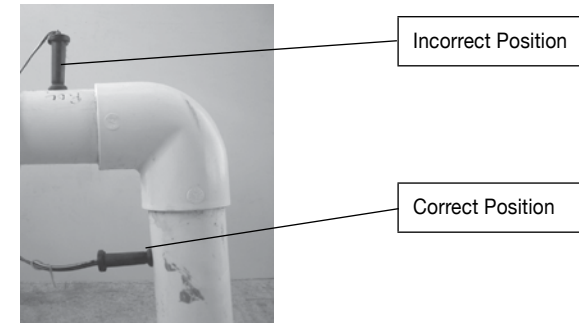

Pool Sensor Installation

Roof Sensor (required if a solar heating system is installed):

- If the sensor lead is to be concealed, e.g. underground, make sure it is run through a conduit to ensure easy removal if service is required.
- To take cable to the roof it should be tied off neatly with electrician's cable ties to one of the solar pipes.
- The roof sensor is supplied housed in a probe holder. This holder should be fixed to the roof in a small pad of adhesive the same angle as the solar absorber. This is to ensure the sensor will measure the actual roof temperature and the reading will be unaffected by the cooler pool water when the solar system turns on.
- The sensor must always be located so it is in the sun at the same time as the solar absorber array; otherwise incorrect readings will be made. This can happen when parts of the absorber are in the shade, and the sensor is still receiving full sunlight.
- The sensor should be located at least 600mm from the top of the roof to eliminate any wind chill factor, 1m from the sides of the roof, and at least 500mm from the solar absorber array to read a constant accurate roof temperature.

Keep the adhesive clear of the cable and also from the top of the holder to facilitate the removal of the probe holder if it should require future service. Suitably clip the lead along its run, to prevent any strain to the sensor holder.

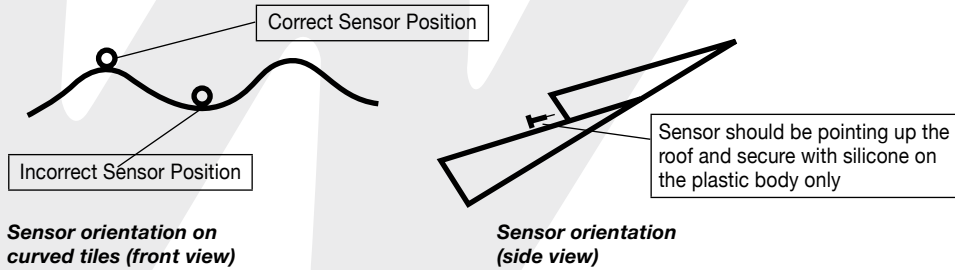

The sensor should be orientated such that it lies on the crest of the roof tiles and not in the troughs. This eliminates water being trapped in the silicon glue that holds the sensor in place, and giving erroneous readings. The roof sensor should also be positioned so that it points up the roof tiles (as shown above).

Air Sensor

Mount the air sensor outdoors and out of direct sunlight.

d. Valve Actuators

The Aquamaster system is optimized to operate Waterco FPI valve actuators and should be installed in consultation with the product installation and operating instructions.



e. Flocheck Valve (optional)

Waterco recommend the Aquamaster system is fitted with the optional Waterco Flocheck valve and should be installed in consultation with the product installation and operating instructions.



FUNCTIONS

The Waterco Flocheck valve has a number of essential functions:

1. As a normal pre-loaded check valve to prevent pool water backwashing the filter on shutoff or drain down.
2. As a pump protection device for when there is no filter water flow. Power is switched off by the solar controller through integration with the Flocheck valve, stopping the pump immediately.
3. As a warning device to highlight the water flow below recommended levels for solar pool system operation.
4. As an adjustable flow switch which can be tailored to the customer's requirements.

INSTALLATION

1. The 'Flocheck' valve should be placed at the end of a straight length of pipe at least 500mm long and before the integrated take-off point. Mounting the valve in this position assumes the water flow is not turbulent at the point of sensing. This is important in order to avoid multiple starts of the boost pump / integrated pump.
2. The valve can be installed in horizontal or vertical pipe. The probe stem should be upright if installation is in the horizontal position for correct action.
3. The valve must be fitted to the direction of the water flow as indicated on the valve body.
4. **WARNING:** when gluing into the line, use cement sparingly so flap is not inadvertently glued in the closed or open position.
5. Remove small bridging plug from the socket of the controller (if present). Push in the plug of the 'Flocheck' valve to the controller.

WARNING: The sensing switch in the unit is rated in milliamps NOT AMPS and will not directly switch 240 VAC power.

FLOW SENSING

PRE-SET THRESHOLD FLOW

The valve has a factory setting 'switch-on' threshold water flow of 60 litre/min and 'switch-off' (30 l/min) threshold point. To change the threshold point the following procedure is to be performed.

- (a) Holding the sensing stem to prevent movement, slightly loosen the knurled lockseal nut.
- (b) Slide the sensing stem to the new position required to accept the water flow characteristics of that particular filter system. The threshold flow is increased by pulling the sensing stem further out from the body and conversely decreased by pushing the stem into the body.
- (c) Lock the stem into position with the knurled lock seal nut.
- (d) Check correct operation of the flow switch. With the integrated pump operating, stop and start the filter system several times.

If the pump continues to operate when there is no water flow, check the functionality of the hinged valve inside the unit for correct operation and debris.

WARNING: when gluing into the line, use cement sparingly so flap is not inadvertently glued in the closed or open position.

Remove small bridging plug from the socket of the controller (if present).

Push in the plug of the 'Flocheck' valve to the controller.

WARNING: the switch in the unit is only rated in milliamps NOT AMPS and will not directly switch to 240 VAC power. Unit is to be connected to the terminal provided in the Aquamaster.

ELECTRICAL

Ensure power is disconnected prior to wiring Aquamaster.

- Follow all statutory and local wiring and installation regulations
- Use copper conductors only

The Aquamaster requires both high and low voltage connections. To gain access to the wiring compartment, insert a flat blade screw driver and half turn anti-clock wise to release the spring loaded locking pin in each corner. Ensure the pins are fully released prior to opening the hinged front panel. The hinged panel may be removed by lifting it upwards from the hinge pins. All connections will be made to the printed circuit board (PCB) inside the control box. These connections include mains supply, hard wired inputs and outputs, actuators, sensors and dry contacts for heater control. When cabling is wired into the Aquamaster Control Enclosure all cable entry points must be sealed to prevent ingress of moisture.

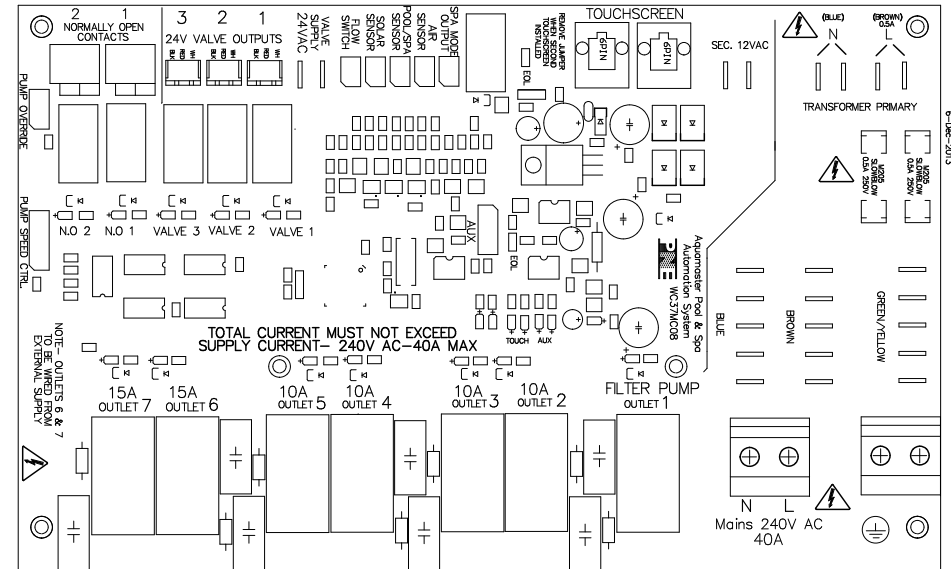

Aquamaster Control PCB layout

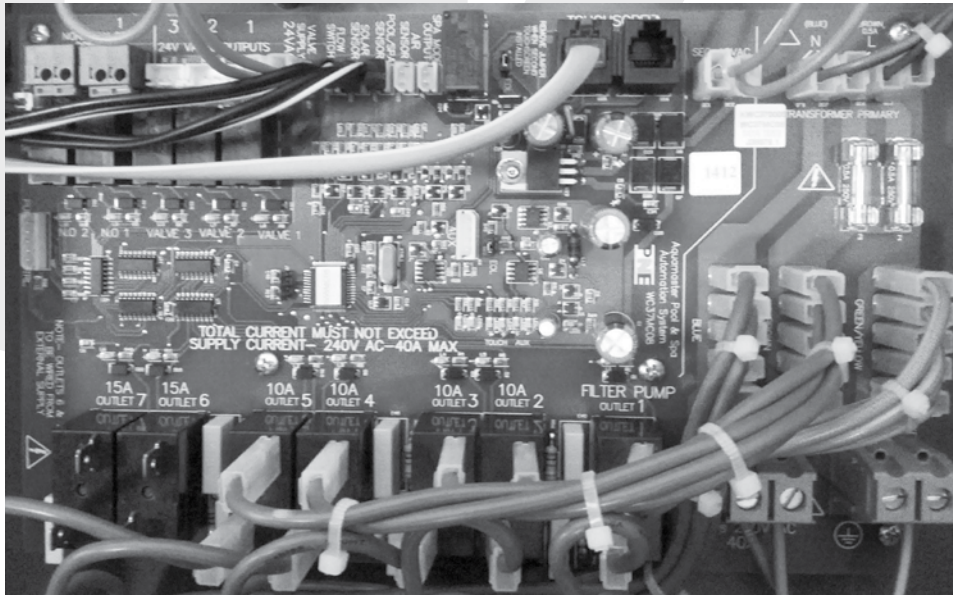

Aquamaster Control PCB image

System Earthing

An earth terminal is located within the compartment of the Aquamaster. Connect an earth wire from the primary electrical supply to the earth terminal.

Input Power Wiring

The Aquamaster requires 240VAC, 40amp maximum input power to operate the control logic circuits, low voltage devices and hard wired socket outlets. This power must be supplied from a maximum 40amp circuit breaker with earth leakage protection in accordance with the wiring rules. It is recommended surge protection be fitted in areas of unreliable power supply or prone to lightning strikes.

The mains power cables should utilize the threaded cable entry point provided on the bottom plate right hand side of the enclosure to ensure electrical segregation between low voltage and extra low voltage cabling.

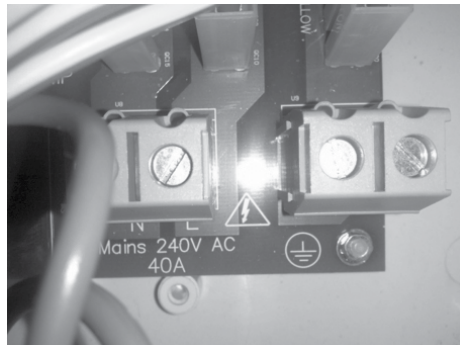

Wiring 15amp switched relays

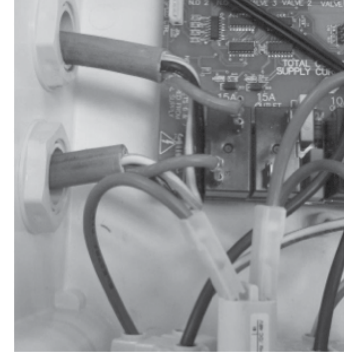

The Aquamaster features 2 x 15amp dry contact switching relays which may be used to operate equipment with an electrical rating of up to 15amps each. Ideally, a separate electrical supply with circuit breaker protection should be connected to each 15amp switching relay numbered 6 & 7 on the PCB.

These power cables should utilize the threaded cable entry points provided in the side of the enclosure to ensure electrical segregation between low voltage and extra low voltage cabling.

Electrical Specification

Input Rating:	240VAC, 50Hz, 40amp max
Output Ratings:	
Relays:	5 x 10A @ 240VAC max sockets with max total output of 40amps 2 x 15A @ 240VAC max dry contacts
Valves:	24VAC, 1A max with max total loading of 2.5amps
Heater:	24VAC, 1A max dry contacts
Enclosure Rating:	IP23
LCD Display Rating:	Not IP rated - if mounting outdoors the unit must be housed in a suitably rated IP enclosure
Approval No.:	SGSEA/NSW26531

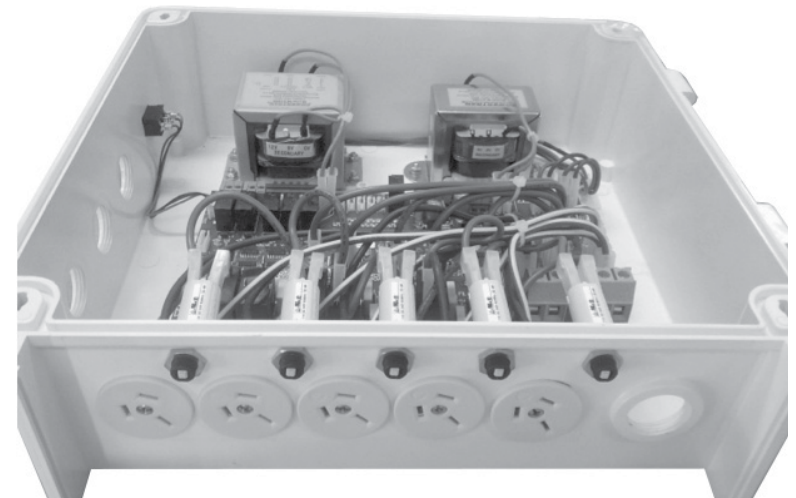

Touch Screen - connection

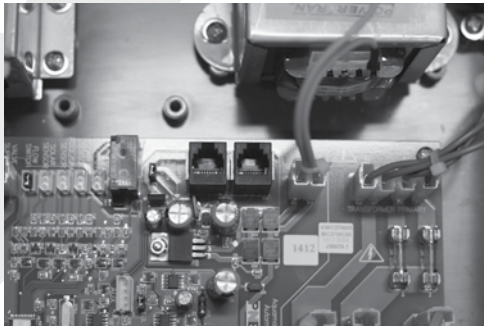
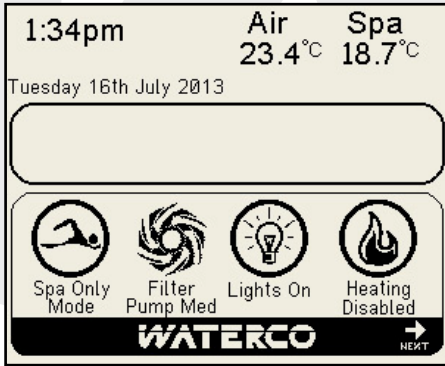

Each touch screen control is to be wired to the Aquamaster Control Box. The maximum cable length from the touch screen control to the Aquamaster Control Box is 50 meters. Recommended minimum cable size is 24AWG (7/020) or Category 5 shielded data cable.

An RJ12 / RJ25 modular plug is to be terminated on both ends of the communications cable between the touch screen control and Aquamaster Control Box. The terminated modular plugs are to be plugged into the rear modular socket of the touch screen control and to the modular sockets marked TOUCHSCREEN on the PCB in the Aquamaster Control Box.

6 position / 6 contact modular plugs		6 POSITION 6 CONTACT MODULAR PLUG
Plug Positions	USOC RJ25	
1	White / Green	
2	White / Orange	
3	Blue / White	
4	White / Blue	
5	Orange / White	
6	Green / White	

RJ12 plug wiring positions for custom control cable termination.

Flow Switch

The Flow switch connection plug must be inserted into the socket labelled FLOW SWITCH within the Aquamaster Control Box to allow the system to operate correctly.

Temperature Sensors

The solar roof sensor (SOLAR SENSOR), pool water sensor (POOL/SPA SENSOR) and ambient air sensor (AIR SENSOR) must be inserted into the relevant socket within the Aquamaster Control Box for the Aquamaster to operate correctly.

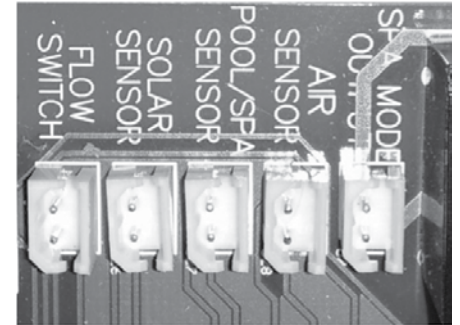

Spa Mode Output

The SPA MODE OUTPUT is a 24V dry contact which is activated when spa mode is enabled. This socket may be used on compatible equipment e.g. reducing the chlorination level to the spa whilst in spa mode. This feature is available on some brands of chlorinators.

The Aquamaster can be paired with a Hydrochlor salt water chlorinator which if connected, is able to drop the chlorination output level suitable for spa use.

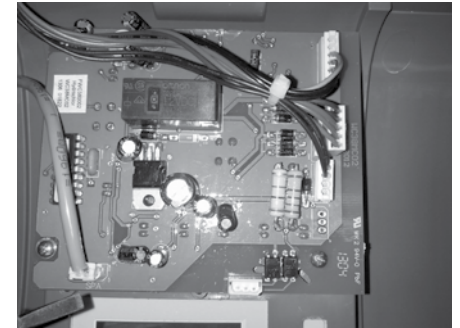

Valve Actuators

The Aquamaster can control up to three automatic valve actuators. Two of the valve outputs are dedicated to the pool/spa suction (Valve1) and return (Valve2) valves. Valve 3 is for general purpose use for diverting water flow to solar, water feature or to an infloor cleaning system.



Heater Control

The Aquamaster provides a set of low voltage dry contacts (labeled NORMALLY OPEN CONTACTS 1 & 2) which may be connected to most gas heaters or heat pumps with 24V control circuits. Refer to the diagram above for connection to the Aquamaster Control system. The manuals supplied with most heaters also include specific wiring instructions for connecting the heater to an external control. Any conventional heater to be controlled by Aquamaster should be set to maximum temperature.

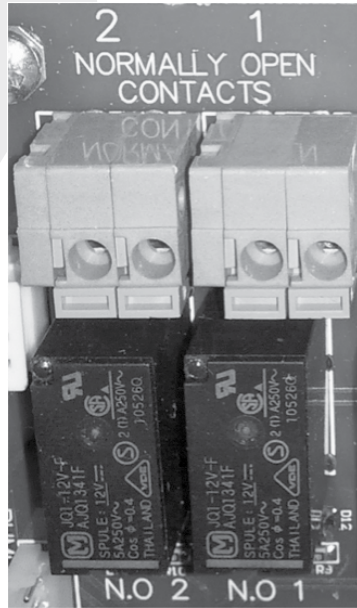

Connection of Communication Cable to Waterco ECO Pumps

Waterco ECO pumps may be purchased with the communication cable fitted. Consult your local Waterco sales office for order details.

Step 1 – Unscrew the 3 x Philips head screws holding the control housing to the motor.

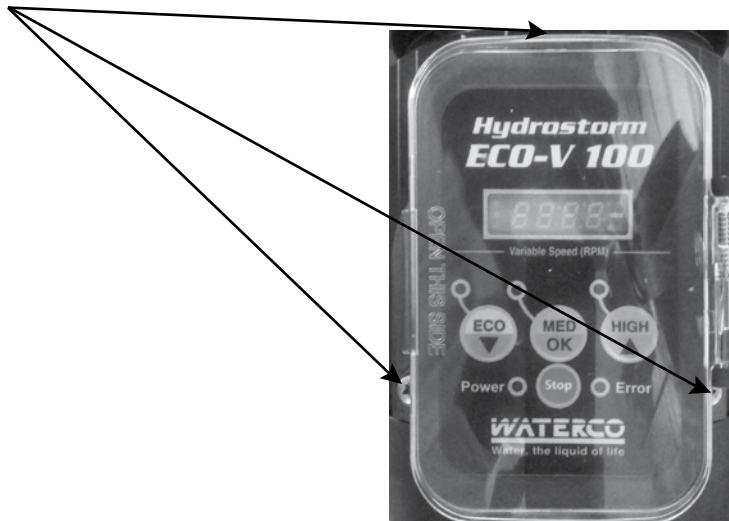

Step 2 – Lift the control housing off the pump to reveal the motor control box.

Step 3 – At the rear of the motor control box drill a 12mm hole at the position indicated in the drawing below. Use stepped drill bit sizes starting at 4mm and working up to 12mm, otherwise there is a high risk of damaging (splitting) motor control box.

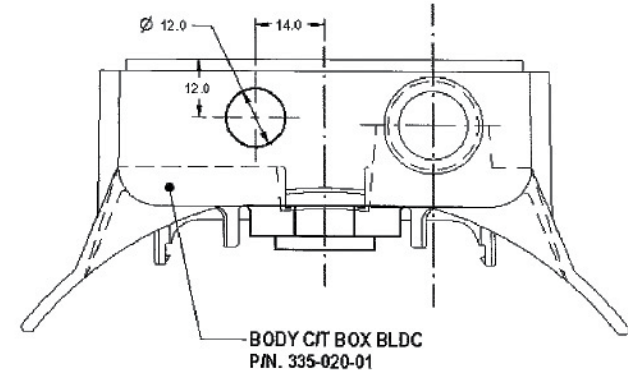

Step 4 – When the hole is drilled remove the locking nut from the cable gland and thread the cable through the hole so that the plug is now located within the motor control box. Thread the lock nut over the cable and screw onto the cable gland and tighten.

Step 5 – Locate the motor control socket on the underside of the control housing and insert the control cable plug and then reattach control housing to the motor control housing.

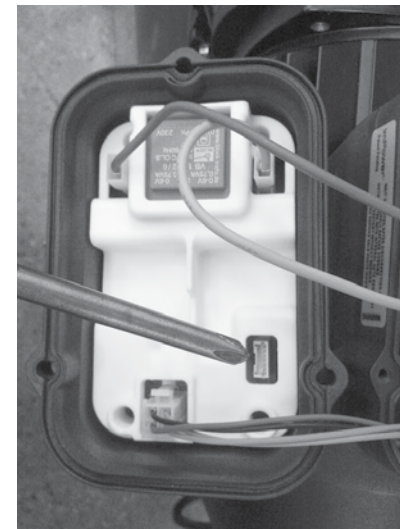

Turbotemp Gas Heater Remote Control Connections

1. Switch off power to heater at main circuit breaker panel.
2. Unbolt and remove the access door panels.
3. Open control box cover (see Figure 23).
4. To connect a 2-Wire Control (such as Waterco Aquamaster™) or a timer:

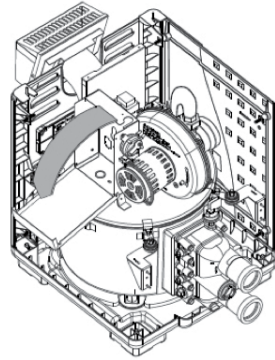

- Remove the factory installed jumper from the Fireman's Switch terminals.
- Connect wires between the Fireman's Switch terminals on the heater and the relay. Connect wires from the controller or timer to the Fireman's Switch. Controller, timer or relay should be sized to handle 24VAC at 0.5 Amp (because it will be completing the 24VAC control board circuit on the heater as shown in Figure 24). DO NOT apply line voltage to the Fireman's Switch terminals. Use 1mm² minimum cable with a minimum 1.2 mm thick insulation rated for a temperature rise of at least 105°C.
- Knock-outs are provided to route the wires through the bottom of the control box and past the junction box.

5. Close control box cover.
6. Re-install the access door panels. To control heaters that are operated in parallel, connect wiring at same locations on heater Control. It is imperative that each control circuit is isolated from the other control circuits, to avoid that current will flow from one heater to another through the control circuits.

NOTICE: The fuse for the Fireman's Switch is a 24V 1.25 Amp 31.75 mm x 6.35 mm fast blow fuse, which is commonly available.

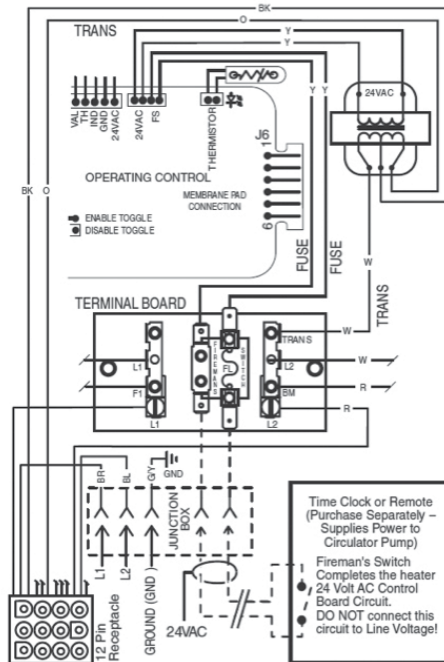

Waterco Heat Pump Remote Control Connections

1. Switch off power to heat pump at main circuit breaker panel.
2. Unbolt and remove the front access panel.
3. Open control box cover.
4. To connect a 2-Wire Control (such as Waterco Aquamaster™) or a timer:
 - Locate the pressure switch on the bottom plate of the electrical enclosure.
 - Cut one of the cables connected to the pressure switch. Connect the two wires from the Controller Normally Open Contact to the two ends of the cut cable and make electrically safe. Controller, timer or relay should be sized to handle 24VAC at 0.5 Amp (because it will be completing the 24VAC control board circuit on the heater as shown in Figure 24). Use 1mm² minimum cable with a minimum 1.2 mm thick insulation rated for a temperature rise of at least 105°C.
5. Close control box cover.
6. Re-install the access panel. To control heaters that are operated in parallel, connect wiring at same locations on heater Control. It is imperative that each control circuit is isolated from the other control circuits; to avoid that current will flow from one heater to another through the control circuits.

Connecting the Controller to operate the Electroheat
 Open the Electroheat electrical control box and locate the pressure switch. Cut one of the blue wires connected to the pressure switch. Connect the two wires run from the heating contact to each of the cut ends of the blue wire.



Pressure Switch

2 core cable from controller

SYSTEM STARTUP AND TESTING

Touch Screen

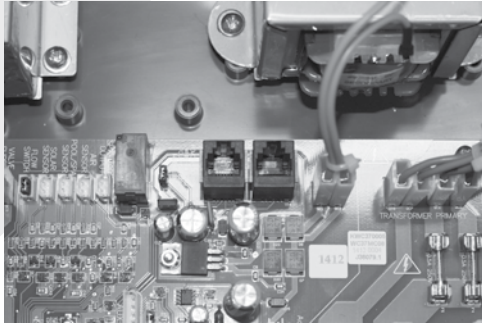
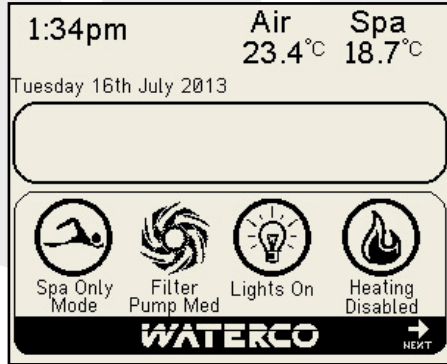

The Aquamaster system comes complete with one touch screen control. An additional screen available separately may be connected providing additional operational convenience to the owner. There is a small jumper link on the circuit board which must be removed.

- a) When two touch screens are installed one will be configured as the “master” and controls all functionality. When the system is first powered up both screens will display the configuration screen.
- b) Whichever screen is used to complete the initial configuration becomes the master unit.
- c) The slave or second screen will reboot and upload all configuration data.
- d) The controller configuration menu will only be available from the master screen.
- e) All user menus will be accessible from the Slave display.
- f) If the master module is disconnected from the system or fails, the controller will restart within a few seconds of being switched on. If the Slave display does not receive a message from the master the slave display will assume master control operation.

Factory Calibration of Temp Sensors

The Reset button will return Aquamaster to factory settings.

CONFIGURATION

Initial Start-up and programming

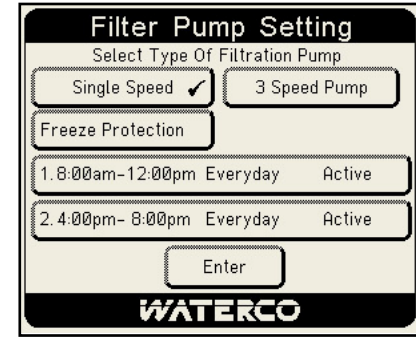

Step 1 – Filter Pump Setting

Select type of filtration pump

- Single Speed
- 3 Speed Pump > Default speed - Low Medium High

Freeze Protection > Off / On

Freeze protection is used to protect the pool hydraulics and plumbed equipment against freeze damage. If freeze protection is enabled and the AIR temperature falls below 3oC, Aquamaster will turn on the filter pump to circulate the water. If in “Pool and Spa” mode the valves will also alternate between the pool and spa every 30 minutes.

- Filtration Timer 1** >set desired start time
- >set desired Stop time
- >set desired days

>Press the “Active” or “Not Active button to allow this timer setting to operate or to deactivate the particular timer setting.

>press “Save Timer” when Timer 1 programming completed

- Filtration Timer 2** >set desired start time
- >set desired Stop time
- >set desired days

>Press the “Active” or “Not Active button to allow this timer setting to operate or to deactivate the particular timer setting.

>press “Save Timer” when Timer 2 programming completed

Press “Enter” to proceed to Pool Spa Configuration

Step 2 – Pool Spa Configuration

Locate the “Press to Configure” icon and scroll to the desired pool configuration setting:

- Pool Only
- Spa Only
- Pool and Spa

Press “Enter” to proceed to configure your selection.

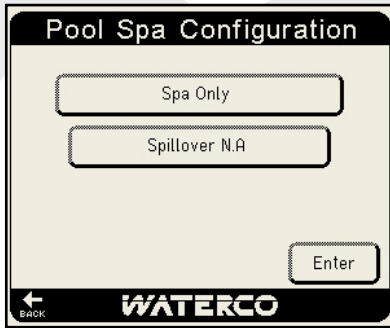

If Pool only is selected” add “press ENTER to proceed to the Pool Heating setup and choose from the following heating types fitted to the pool.

- Pool Heating > Select your heating requirements
 - > No Heating
 - > Heat Pump
 - > Gas Heater
 - > Solar
- Press “Enter” to proceed to configure your selection



If “Gas Heater” or “Heat Pump” is selected the “Gas Heater Settings” or Heat Pump Settings” Menu will appear.

Is the heater independent of or integrated to the filtration system?

Integrated Conventional Heater - “Integrated” should be selected for a conventional heater operating within the filtration circuit.

Independent Conventional Heater - “Independent” should be selected for a conventional heater operating separately to the filtration circuit.

Select either the “Independent” or “Integrated” icon relevant to your pool hydraulic configuration.

Press the “Temp Check Period” icon to alter the period between Aquamaster checking the pool temperature via operation of the filter pump or independent pump. After the desired pool / spa temperature is reached the pump switches off but will operate again at the set “Temp Check Period” monitoring the pool / spa temperature. If the pool / spa are below the desired set temperature, the pump will remain on and provide water flow to the heater. The period may be set to check between one and four hours in half hour increments with the default at 2 hours.

Press the “Heater Timer” icon to set the heater operation times.

If “Integrated” is selected a “Heating Demand Option” icon will appear. Effectively, if this function is activated it will override the filtration pump’s timer setting and will keep the heater heating the pool water until the set temperature is reached. The Heating Demand Option may be controlled by the Demand Mode.

Timer which is accessed via the “Demand Mode Timer” icon. Press “Enter” to proceed to configure your selection.

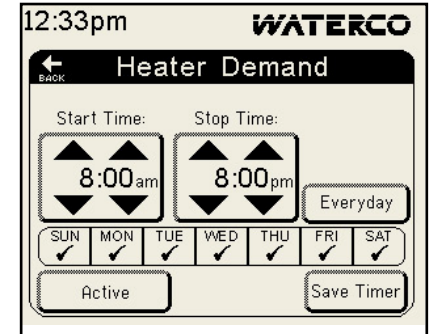
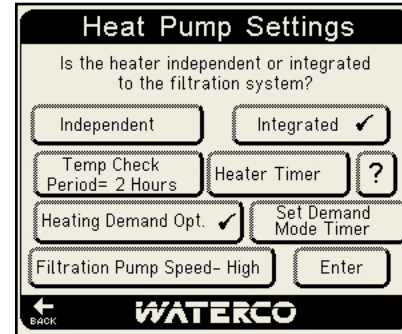

If “Solar Heating” was selected the “Solar Heating Settings” Menu will appear.

Is the Solar independent of or integrated to the filtration system?

Select either the “Independent” or “Integrated” icon relevant to your solar hydraulic configuration.

Press the “Temp Check Period” icon to alter the period between Aquamaster checking the pool temperature via operation of the filter pump or independent pump. After the desired pool / spa temperature is reached the pump switches off. The pump will operate again at the set “Temp Check Period” monitoring the pool / spa temperature. If the pool / spa are below the desired set temperature, the pump will remain on and provide water flow to the solar system. The period may be set to check between one and four hours in half hour increments with the default set at 2 hours.

Solar Preference

The solar heating function may be given priority over other forms of heating by selecting the “Solar Preference” icon. The “Solar Preference” feature should be selected if the solar heating is to have operational priority over a conventional heater.

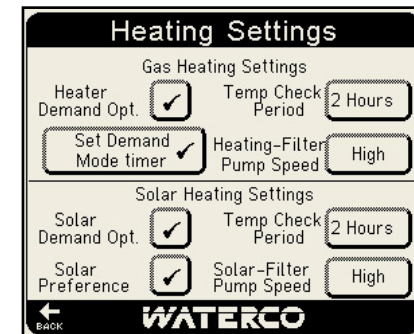

If the solar heating hydraulic configuration is “Integrated” then the user may need to select the method of solar output by toggling between “Solar Pump” and “Solar Valve”. Where the solar system is part of the filtration circuit and the pool water is diverted after the filtration system generally a secondary pump is required to boost filtered water up to the solar system absorber on the roof and returns the heated water back to the pool via the existing pool return line. If a Waterco ECO pump is fitted, a secondary pump may not be required and the pool water may be diverted to the solar system absorber via an actuated valve.

If the filtration pump is a Waterco ECO pump the user may need to alter the pump speed by pressing the “Filtration Pump Speed” icon and toggle between “Medium / High” speed.

Cleaning Settings

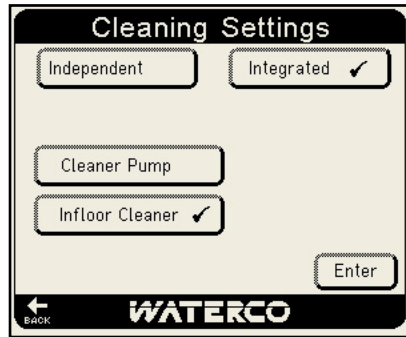
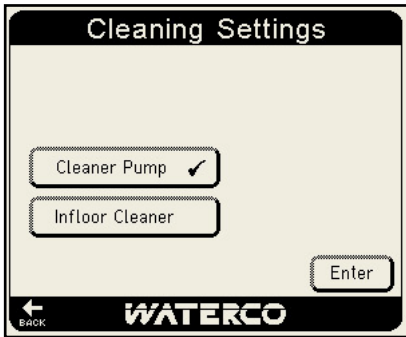
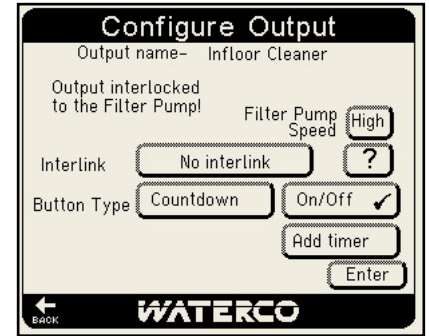
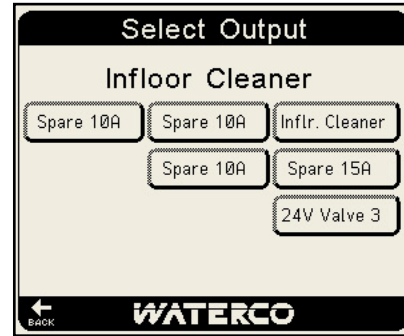

There are two Cleaner options which may be selected by pressing either the “Cleaner Pump” or “Infloor Cleaner” icons. If neither cleaning option is fitted press “Enter” to continue to the next screen.

If a pressure pool cleaner is installed and equipped with a pressure pool cleaner pump select the “Cleaner Pump” icon and press “Enter”.

To select the control output for the Cleaner Pump press either the “Spare 10A” icon to assign a three pin plug socket outlet or the “Spare 15A” icon to assign a separately wired contact rated at 15 amps and press :”Enter” to continue to the next screen.

To select the control output for the Infloor Cleaner press either the “Spare 10A” icon to assign a three pin plug socket outlet or the “Spare 15A” icon to assign a separately wired contact rated at 15 amps and press :”Enter” to continue to the next screen.

Prior to assigning control outputs for cleaner pumps check the appliance electrical requirements.

Lighting Setup

If the installation is fitted with a pool light, water feature light or Outdoor Light ensure the appropriate icon is selected. The type of pool light may be selected between by toggling between “Generic” or “Waterco Multicolour LED”. If a Waterco Multicolour LED light is paired with Aquamaster the colour selection programming feature is enabled through the touch screen control.



Once initial setup has been completed select the “System Overview” icon to display electrical outlet allocations.

If Pool and Spa is selected

If a Spa Spill over is featured in the installation ensure either option a. or b. is selected as detailed below:

- a. If the “Spill over – Spa Return” icon is displayed the automated valves should be configured to take water from the pool and return pool water via the spa.

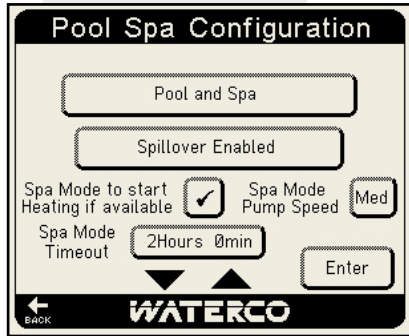

- b. If the “Spillover – Pool / Spa Return” icon is displayed the automated valves should be configured to take water from the pool and spa and return water in the same proportions back to the pool and spa.

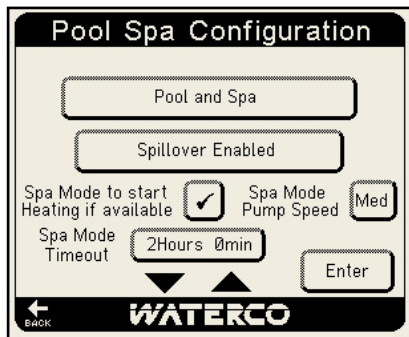

If heating is to start when SPA MODE is selected ensure the check box is ticked and Spa Mode Timeout is programmed and press Enter to the next screen.

- Pool Heating > Select your heating requirements
- > No Heating
- > Heat Pump
- > Gas Heater
- > Solar

Press “Enter” to proceed to configure your selection.

If “Gas Heater” is selected the “Gas Heater Settings” Menu will appear.

If “Heat Pump” is selected the “Heat Pump Settings” Menu will appear.

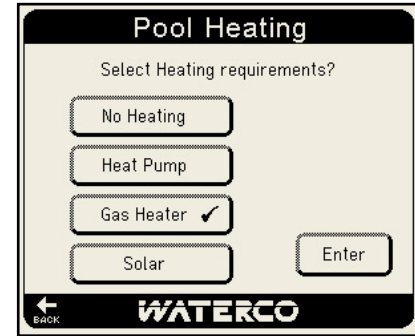

Is the heater independent of or integrated to the filtration system? Select either the “Independent” or “Integrated” icon relevant to your pool hydraulic configuration.

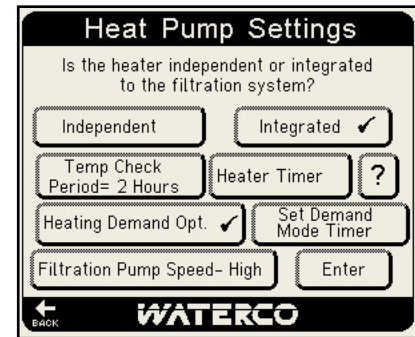

Press the “Temp Check Period” icon to alter the period between the system checking the pool temperature via operation of the filter pump. The period may be set to check between 1 and four hours in half hour increments.

Press the “Heater Timer” icon to set the gas heater operation times.

If “Integrated” is selected a “Heating Demand Option” icon will appear. Effectively, if this function is activated it will override any filtration timer setting and will keep the gas heater heating the pool water until the set temperature is reached. The Heating Demand Option may be controlled by the Demand Mode Timer which is accessed via the “Demand Mode Timer” icon.

Press “Enter” to proceed to configure your selection.

If “Solar Heating” was selected the “Solar Heating Settings” Menu will appear.

Is the Solar independent of or integrated to the filtration system?

Select either the “Independent” or “Integrated” icon relevant to your solar hydraulic configuration.

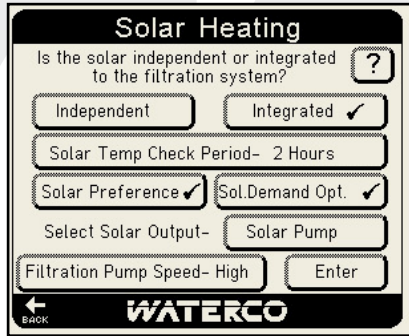

Press the “Solar Temp Check Period” icon to alter the period between the system checking the pool temperature via operation of the filter pump. The period may be set to check between one and four hours in half hour increments.

The solar heating function may be given priority over other forms of heating by selecting the “Solar Preference” icon.

If the solar heating hydraulic configuration is “Integrated” then the user may need to select the method of solar output by toggling between “Solar Pump” and “Solar Valve”.

If the integrated system filtration pump is an ECO pump, the user may need to alter the pump speed by pressing the “Filtration Pump Speed” icon and toggle between “Low / Medium / High” speed.

Cleaning Settings

There are two Cleaning options which may be selected by pressing either the “Cleaner Pump” or “Infloor Cleaner” icons. If neither cleaning option is fitted press “Enter” to continue to the next screen.

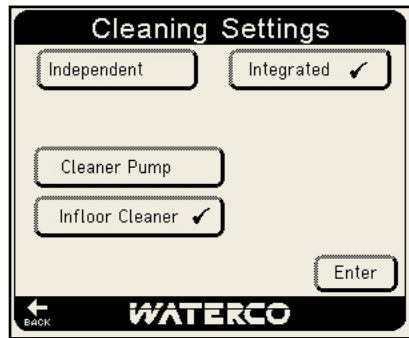
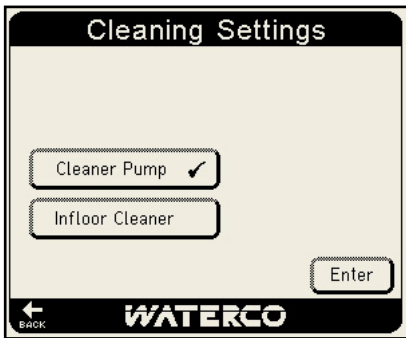

If the installed system is fitted with a Cleaner Pump select the “Cleaner Pump” icon and press “Enter”.

To select the control output for the Cleaner Pump press either the “Spare 10A” icon to assign a socket outlet or the “Spare 15A” icon to assign a separately wired contact rated at 15 amps and press :”Enter” to continue to the next screen.

To select the control output for the Infloor Cleaner press either the “Spare 10A” icon to assign a socket outlet or the “Spare 15A” icon to assign a separately wired contact rated at 15 amps and press :”Enter” to continue to the next screen.

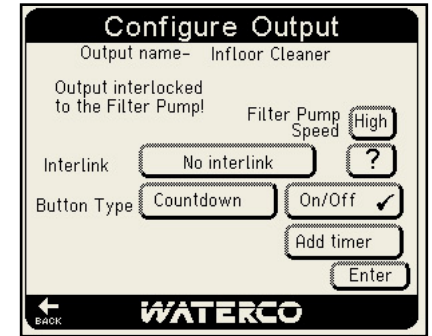
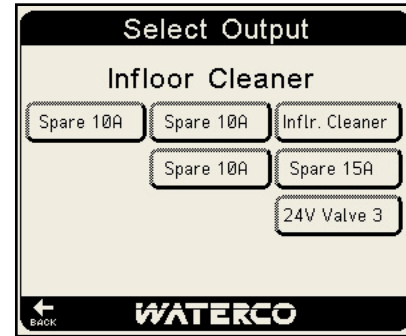

Lighting Setup

If the installation is fitted with a pool light, water feature light or Outdoor Light ensure the appropriate icon is selected. The type of pool light may be selected between by toggling between “Generic” or “Waterco Multicolour LED”



Once initial setup has been completed select the “System Overview” icon in the Configuration menu to determine outlet allocation.

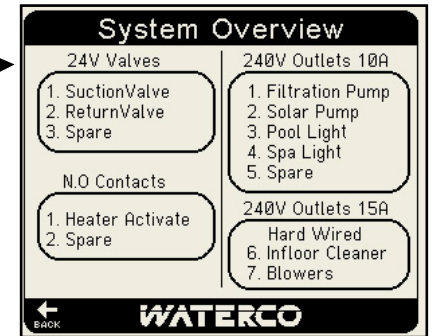
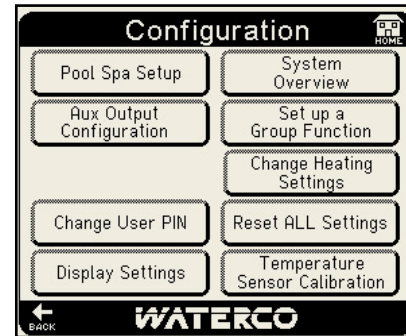

OPERATION

Filter Pump Speed Selection

Filter Pump Icon on Home screen

- a) If a single speed filter pump is connected the filter pump icon will be a simple On Off function.
- b) If a Waterco ECO pump is connected the filter pump icon will allow the user to scroll through and select the desired pump speed. The Waterco ECO pump has an inbuilt priming function which does not allow speed changes during priming.
- c) When the filter pump is not operating and the filter pump icon is pressed the filter pump will default to the preset pump speed.
- d) If the filter pump is running and the flow switch does not close after two minutes the system will request the pump to turn off. Heating cool down must be complete if operating integrated gas heating.
- e) A green led on the LCD display panel will be illuminated if flow is detected.
- f) When a new item is activated which is interlocked to a Waterco ECO pump the pump speed may need to increase to provide adequate water flow.
- g) The LCD display panel may display the message "Pump Speed Limited" if a person attempts to select a pump speed below the required speed of an interlocked function.
- h) When the filter pump is deactivated, it will also deactivate all interlocked outputs.
- i) When any interlocked function is deactivated – the control will check if other interlocked outputs are running and lower the filter pump speed to either the minimum required by any running function or to the filter pump default speed from the pool/spa configuration menu if within a filtration time.
- j) If an interlocked function is deactivated, no other interlocked functions are operating and not within a filtration time zone filter pump will be deactivated.

Pump Override function (External Switch)



- I – Automatic, controlled by LCD control panel
- O - Pump off
- II – Pump override service mode, full speed:
 - a) Pump will run at full speed if a Waterco ECO pump is installed- all other outputs will be disabled
 - b) Pump override message will be displayed on touch screen if switch is not in centre position.
 - c) Pump override is a complete override and will disable pump even in heating cool down.
 - d) Pump override will disable all functions on touch screen.
 - e) Valve relays will default to off position

Freeze Protection

- a) If freeze protection has been enabled and the air temperature decreases below 3°C and the filter pump is not operating the unit will activate the filter pump.
- b) The filtration pump will turn back on if manually switched off in the condition.
- c) When the system is powered up and configured, if the current time is within one of the filtration times the filter pump will operate. If a mains power outage occurs the filter pump will restart as normal.

Valve 1, 2 and 3 Operation

- a) If an Aux icon has been configured to control a valve without the "Pump Off Valve Change" setting selected and interlocked to filtration pump, activating the Aux icon will switch on the filtration pump if not already operating and allows three minutes for the pump to prime itself, the pump speed will automatically shift to its pre-programmed pump speed and the valve will rotate.
- b) If the filtration pump is operating and the Aux Valve icon is activated the valve will check pump speed, adjust to the preset speed and wait one minute before activating the valve.
- c) If valves are configured to switch from pool to pool / spa spill over mode the filter pump will switch off during each rotation.

Infloor Cleaner

- a) Configuring the infloor cleaner as an independent system allows it to be operated at any time unless SPA mode is active.
- b) Configuring the infloor cleaner as an integrated system means the filtration pump must be running for 3 minutes prior to the operation of the infloor cleaner valve or the pump operation.
- c) Configuring the infloor cleaner to be manually activated by a valve by pressing the infloor cleaner button the control will activate the filtration pump and wait three minutes to prime itself, the pump speed will automatically shift to its pre-programmed pump speed and then the valve will be activated. The filtration pump will not turn off during rotation of the infloor cleaner valve to ensure the pump holds its prime.

Lights Icon Home Screen

- a) If lighting control is selected in configuring the system the "lights" icon will display on the home screen.

Pool Spa Mode Selector Icon

- b) The Pool / Spa mode icon is not operational on pool only or spa only systems.
- c) Press the Pool / Spa icon to switch between pool, spa and spill over modes.
- d) When changing between Pool, Spa and Pool/Spa modes there is a five second delay prior to the system actioning the request.
- e) If the filtration pump is running and the pool/spa mode is changed after a five second delay the control will switch the filtration pump off.
- f) If the system has a gas heater fitted the heater cool down period will deactivate the filter pump after the cool down period is complete.
- g) If spa mode is selected and the filtration pump is not activated the control will activate the filtration pump.
- h) If spa mode enables the heating option (default enabled) the control will enable solar and conventional heating.
- i) In Pool Mode Suction (valve 1 relay) and Return valve (valve 2 relay) will be directed to the pool.
- j) In Spa mode Suction (valve 1 relay) and Return valve (valve 2 relay) will be directed to the spa.
- k) In Pool and Spa mode Suction (valve 1 relay) valve will be directed to the pool and the return valve (valve 2 relay) will be directed to the spa.
- l) If Spa mode is enabled the cleaner functions of infloor and cleaner pump will be disabled.

Heating

- a) In Spa mode the heating set temperature will be the spa temperature.
- b) In Pool or Spill Over modes the heating set temperature will be the pool temperature.

Conventional Heating Operation Modes

- a) If the system detects a faulty pool temperature probe conventional heating will be disabled.
- b) If heater demand is enabled and a Heating timer has been programmed to turn Heating off- it will not disable the conventional heating.
- c) The operator may manually disable a conventional heater or heater demand.
- d) If an operator switches the system to spa mode the chosen heating option is enabled.

- e) Note- if this option is selected if a group function is activated and the spa mode option is selected heating will start regardless of the group heating setting.
- f) Demand Mode timer- Currently at the end of the heater demand timer, if the controller is not within a filtration timer and no other interlocked functions are operating the controller will request the filter pump to turn off which will disable heating. This feature is only available for integrated systems.
- g) If the filtration pump is turned back on outside the demand mode timer heating will recommence.
- h) Heater enable/disable stop time is disabled during demand mode.
- i) Demand mode will be disabled at the start or end of any group function - not available in a group function.
- j) Heater demand button will only be available during heater demand mode timer times.

Integrated Conventional Heating

- a) The filtration pump must be running for three minutes to prime itself, before the heater is enabled.
- b) If gas heating is selected the filter pump must run for 6 minutes after heater is disabled for heater cool down.
- c) Normally open contacts will be allocated for conventional heater activation.
- d) If the filtration pump is turned off manually or timer off event happens, the controller will switch the normally open Heater Contacts off and set the "Heating temp check delay" (for use only with heater demand).
- e) In a pool system with Solar and conventional heating with solar preference selected, solar heating only will operate when there is solar gain.
- f) If Heating Demand is enabled-the Heating temperature check delay is cleared.
- g) The "Heating temperature check delay" is controlled by countdown timer.
- h) If the filter pump has been operating for over three minutes, the flow switch closed for 20 seconds and the pool temperature is one 1°C less than the set temperature the heater option is enabled.
- i) If the heater is on, the filter pump has been running for over three minutes and the pool temperature is +3°C greater than the set temperature, the heater control output will set the "Heating temperature check delay" for the "Heating temperature check period".
- j) If the filter pump was operated due to the 'Heater demand temperature check" then the filter pump will deactivate.
- k) When heater demand is enabled the "Heater temp check delay" is cleared.
- l) If heating demand is enabled, the "Heating temp check delay" has completed and the filtration pump is not operating, it will enable the "heater demand temperature check" and operate the filter pump.
- m) Heater Demand setting will be disabled after the "Heater Demand Maximum operating time".
- n) If any valve needs to change position the unit will queue the change after the gas heater cool down period.
- o) The heater output will deactivate the gas heater unit but will keep the filter pump operating for fifteen minutes then deactivate for forty seconds as the valve changes position. The filter pump will operate and after a three minute delay the heater output will enable if required.

Independent Conventional Heating

- a) The Heater Pump must be running for three minutes to prime itself before a heater is enabled.
- b) If Gas heating is selected the pump must run for six minutes after the gas heater is disabled for cool down.
- c) Normally open contact No.1 will be allocated for heater activation. Relay three is allocated for an independent heater pump.
- d) In a pool system with Solar and conventional heating, if solar preference has been selected and solar is enabled with solar heat gain detected any convention heater will not operate. If Heating Demand is initially enabled-the Heating temp check delay is cleared.
- e) The "Heating temp check delay" is on countdown timer.
- f) If the heater pump has been operating for over three minutes and the flow switch closed for twenty seconds and the pool temperature is 1°C less than the set temperature the heater option is enabled.
- g) If Heater is on and the heater pump has been running for over three minutes and the pool temperature is + 3°C greater than the set temperature, the heater control output will deactivate set the "Heating temperature check delay" for the "Heating temperature check period".
- h) The Heater pump output will turn off after the cool down period.
- i) If when the Heater demand is first activated the "Heater temp check delay" is cleared.
- j) If the Heating demand is enabled and the "Heating temp check delay" has finished and the heater pump is off turn on the "heater demand temperature check" and turn on the heater pump.
- k) The Heater Demand setting will be disabled after the "Heater Demand Max run time". Note- the Heater pump will not stop if a valve change request has been initiated.

Solar Heating operation-

Operation modes

- a) If there is a faulty solar or pool temp probe solar is disabled.
- b) The user can manually disable solar or solar demand.
- c) Pool Temperature will be displayed on the LCD Control Panel home screen if the filtration pump is operating, solar output is enabled or heater output is enabled.

Solar Valve Operation (integrated system)

- a) If the filtration pump is turned off manually or timer off event happens the controller will switch the solar valve off and set the "solar temp check delay" (for use with solar demand).
- b) If solar demand is enabled-the solar temp check delay is cleared.
- c) The "solar temp check delay" is on countdown.
- d) If the filtration pump has been running for over three minutes and the flow switch closed for twenty seconds and the (pool temp - 1°C) is less than the set temp and solar enabled option is enabled and the solar valve is off and the "solar temp check delay" has finished and the solar temp is +5°C more the pool temp, turn the filtration pump off and switch the valve to activate flow to the solar pipes and reactivate the filtration pump.*
- e) If solar valve is on and the filtration pump has been running for over three minutes and the (pool temp + 0.3°C) is greater than the set temp turn the filter pump off switch the valve off then reactivate the filtration pump. Set the "solar temp check delay" for the "solar temp check period" on solar demand systems.

- f) If the solar valve is on and the filtration pump has been running for over three minutes and the solar temperature is less than the (pool temperature - 0.5°C) then turn the filtration pump off and turn off the solar valve, if the filtration pump wasn't running because the "heater demand temperature check" then wait thirty seconds and operate the filter pump and set the "solar temp check delay".
- g) For the "solar temp check period". Solar Temp check period for systems with solar heater demand enabled can be adjusted; otherwise the check delay is set for 2 Hours.
- h) If when the solar heating demand is first activated the "solar temp check delay" is cleared.
- i) If the solar heating demand is enabled and the "solar temp check delay" has finished and the filtration pump is off turn on the "solar demand temperature check" and turn on the filtration pump.
- j) Solar Demand is independent of solar enabled solar demand will run until solar demand is manually disabled. Solar demand will only run between 7am and 9pm.

Solar Booster Pump Operation (integrated system)

- a) If the filtration pump is turned off manually or timer off event happens the controller will switch the solar booster pump off and set the "solar temp check delay". If solar demand is enabled-the solar temp check delay is cleared.
- b) The "solar temp check delay" is on countdown timer.
- c) If the filtration pump has been operating for over three minutes and the flow switch closed for twenty seconds, pool temperature - 1°C is less than the set temperature, solar enabled, the solar booster pump is not operating and the "solar temp check delay" has finished and the solar temp is +5°C more the pool temp, the solar boost pump will activate. If solar booster pump is on and the filtration pump has been running for over three minutes and the (pool temp +0.3°C) is greater than the set temp turn the solar booster pump off. Set the "solar temp check delay" for the "solar temp check period" on solar demand systems.
- d) If the solar booster pump is on and the filtration pump has been running for over three minutes and the solar temperature is less than the (pool temperature -0.5°C) then deactivate the solar booster pump, turn off the filter pump if running to check pool temperature.
- e) Set the "solar temp check delay" for the "solar temp check period". Solar Temp check period for systems with solar heater demand enabled can be adjusted; otherwise the check delay is set for two Hours.
- f) If when the solar heating demand is first activated the "solar temp check delay" is cleared.
- g) If the solar heating demand is enabled and the "solar temp check delay" has finished and the filtration pump is off turn on the "solar demand temperature check" and turn on the filtration pump. Solar Demand is independent of solar enabled solar demand and will run until solar demand is manually disabled. Solar demand will only run between seven am and nine pm.

Solar Pump Independent

- a) If solar is enabled and the (pool temp - 1°C) is less than the set temp and solar enabled option is enabled and the solar pump is off and the "solar temp check delay" has finished and the solar temp is +5°C more the pool temp, activate the solar pump.
- b) If solar pump is on and (pool temp + 0.3°C) is greater than the set temp turn the solar pump off and Set the "solar temp check delay" for the "solar temp check period" on solar demand systems.
- c) If solar pump is on and the solar temperature is less than the (pool temperature - 0.5°C) then turn off the solar pump. If solar is disabled turn off the solar pump.

Group function solar operation

- If a group function is activated all other timer functions are disabled.
- In Group functions interlinks do not function. Individual functions can still be manually turned on and off.
- Activating a group function deactivates any other group function that is currently enabled. This does not apply to the lighting group function button on the home screen.
- In the group setup- if a variable speed pump is used and the user sets an individual function that requires high speed operation the user will not be able to change the pump speed to a lower setting then the individual function.
- On deactivation of a group function heating demand is disabled.
- When any group function is operating all countdown timers are deactivated except for blowers countdown which is limited to a maximum of twenty minutes.
- Group Function Lighting Colour- When a group is activated and a different lighting colour is chosen the Waterco Multicolour LED light must be set to turn on or the lighting colour will not change.

h) Activation of a group function-

- The options in a group function that have the “turn off” option selected will turn off.
- The options in a group function that the option ‘turn on’ selected will turn on.
- The Heating settings / pump speed and lighting for the group will be activated.

i) Deactivation of a group function

- The options in a group function that have the “turn off” option selected will remain unchanged.
- The options in a group function that the option ‘turn on’ selected will turn off.
- The Heating settings/ pump speed will return to the previous setting.
- NOTE- The filtration pump will not turn off if within its filtration time. Instead it will lower speed to minimum required or default.

Group Button Configuration

Enter the “Set up a Group Function” screen via the Configuration Menu.

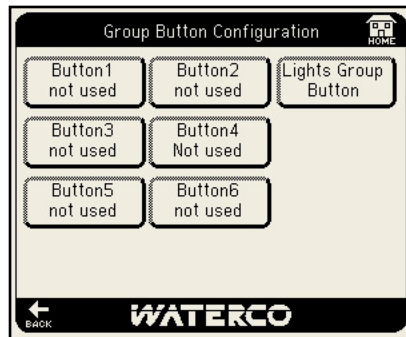
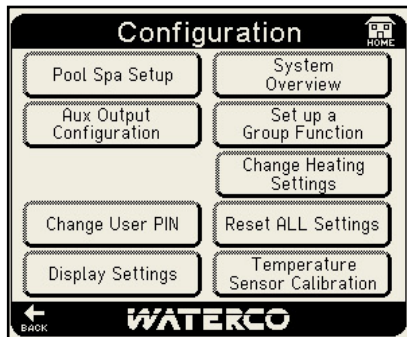

To program a group button press any icon showing “not used”. On the next screen press the icon “Edit Group Button” which allows the programmer to select from installed equipment a pre programmed sequence of multiple functions operated from one named icon.

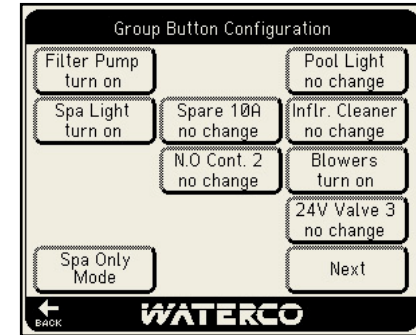

An example of a group function is detailed below for a SPA Party.

Toggle the Mode icon to the Spa Only Mode setting which will activate a conventional heater and reconfigure the hydraulic system to operate the spa via the actuated valves.

Press the Filter Pump icon to show “Turn On”.

Press the SPA light icon to show “Turn On”.

Press the SPA Jet Pump icon to show “Turn On”.

Press the Blowers icon to show “Turn On”.

When the equipment has been selected for the group function press the “Next” icon to progress to the next screen.

Press the icon “Press to assign name” which allows the user to name the group function via the on screen keyboard and press “enter” when completed.

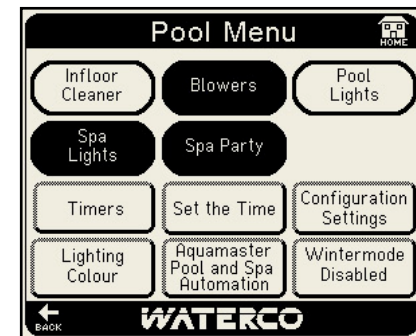

On the next screen press the heating icon to display the desired spa heating method and use the up and down arrows to select the desired set temperature.

Press the up and down arrows on the Group Countdown icon to select the desired countdown timer period.

Press the Pump Speed icon to select the desired pump speed for the group setting.

When the programming has been completed press the “Save Group” icon and return to the Group button configuration screen.

To utilise the “Pool Party” group button proceed to the Pool Menu screen and select the icon “SPA PARTY”.

Aux Configuration Screen

- a) Only Available outputs will be displayed.
- b) The operator cannot interlink to solar pump, heater output, heater pump or suction and return valves.

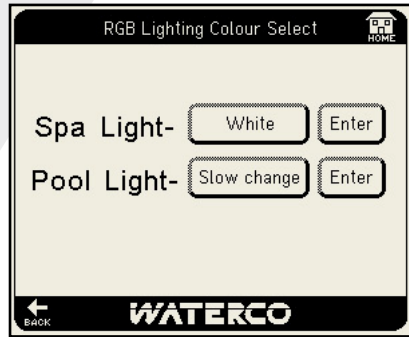
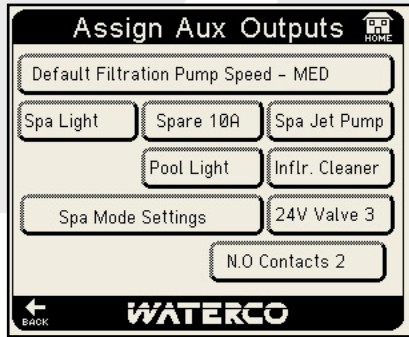

RGB Lighting Sync Menu

- a) If Waterco Multicoloured LED lights are installed the user may select a colour for pool and spa lights.
- b) In Pool Menu > Lighting Colour, selecting the sync button next to the lighting colour will start the lighting sync sequence. This may take up to twenty seconds. First, the lights will switch 10 times to sync to white then will select the required lighting colour. The lighting output will be activated when the lighting sync button is selected.
- c) Lighting colour will always display default on entry to this screen. If the user switches the light off during this sequence the lighting colour will be the last colour that was on next time activated.
- d) When switching the lights off and then on quickly, the selected colour setting may be lost. Ensure 30 seconds have elapsed between switching off then on to ensure the preset colour is maintained.

Temperature Sensor Calibration

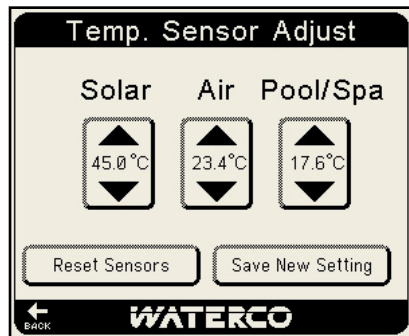
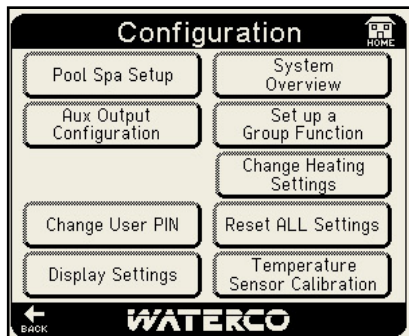

In some installations accurate temperature readings may be required. The Aquamaster includes a temperature sensor adjustment function which allows the installer / owner to calibrate the temperature output from the air, pool and roof sensors. This setting may be achieved by using a calibrated external thermometer to accurately measure the water, air and roof temperatures. To calibrate the Aquamaster to the external temperature readings use the up and down arrows relevant to the sensor requiring adjustment on the LCD control panel through the “Temp. Sensor Adjust” screen selectable through the Configuration menu screen.

Display Settings

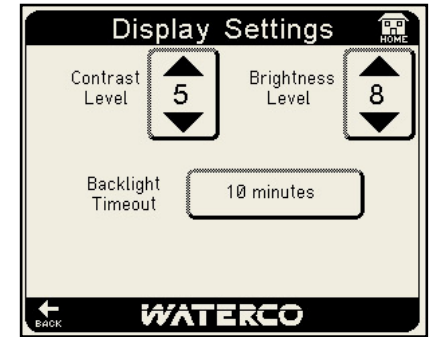
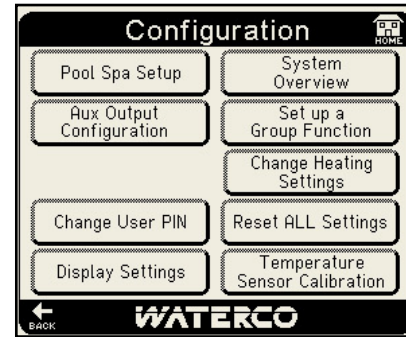

The user may adjust screen settings of Contrast Level and Brightness Level by selecting the relevant icon up and down arrows to the desired display setting. The backlight timeout may also be adjusted by pressing the relevant icon until the desired timeout is selected.

Changing Configuration Menu PIN Number

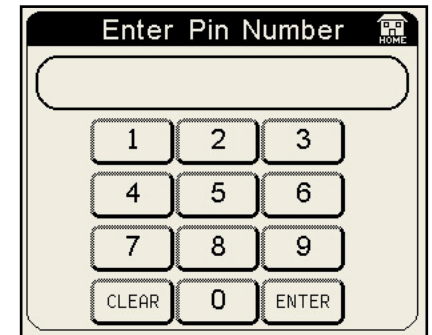
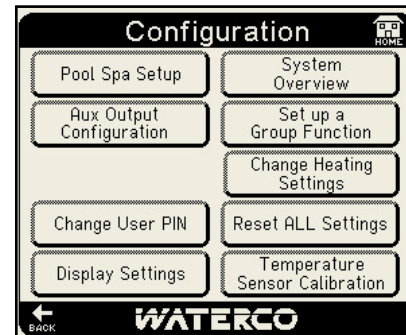

The Aquamaster default PIN code is 1234 > Enter. To change the PIN enter the “Change User PIN” screen through the Configuration Menu. Enter the new PIN > Enter and then Confirm New PIN by re entering the same PIN number again > Enter.

Warranty - PLEASE READ

[Important note: The benefits under this warranty are in addition to other legal rights and remedies you may have in relation to Waterco products]

1. These terms and conditions carefully, as failure to comply may affect your legal rights under this warranty; and
2. Any operation instructions carefully before commencing use of any product manufactured by Waterco Limited ("Waterco").
3. Waterco manufactures quality pool and spa products to the highest standards using the most advanced technology and production procedures available.

WARRANTY COVER

If a defect occurs in any Waterco product during the warranty period, Waterco will at its discretion, repair the product or replace and install the defective part, free of charge provided that the defect results solely from poor workmanship or materials and subject to these terms and conditions.

Labour is covered by this warranty for a period of twelve months from the date of purchase or installation, within a 25 km (15 miles) radius of an authorized Waterco Service Agent.

The purchaser is responsible for any freight incurred.

Warranties are valid only within the original country of purchase. Our goods come with guarantees that cannot be excluded under the Australian Consumer Law [applicable only to Australian States and Territories]. You are entitled to a replacement or refund for a major failure and compensation for any other reasonably foreseeable loss or damage. You are also entitled to have the goods repaired or replaced if goods fail to be of acceptable quality and the failure does not amount to a major failure.

WARRANTY PERIOD

All products sold by Waterco are covered by a one year warranty. The exceptions to this are the products listed in the schedule (which also specifies relevant warranty periods). All warranty periods commence on the date of purchase by the end user.

The provisions of this warranty are not transferable and are in addition to and not in modification of or subtraction from any applicable statutory warranties, rights or remedies.

CONDITIONS OF WARRANTY

This warranty only applies where:

1. The products requiring installation have been sold with installation included and have been installed by a licensed plumber, electrician or person who has completed an accredited course in swimming pool care and maintenance or a person with more than 12 months on the job learning
or a person supervised by one of these people, in accordance with any written installation instructions provided.
2. The products have been installed and operated in accordance with written instructions supplied by Waterco;
3. The purchaser is able to provide proof of purchase that specifies the date of purchase;
4. The product has been serviced or maintained regularly.
5. Installed in an area that is free from flooding or excessive outside contact with water;
6. Any pool and spa equipment has been used in water:
 - a. With a temperature not exceeding 40°C degrees Celsius;
 - b. With a pH range maintained between 7.2 – 7.6;
 - c. That has been chemically balanced in accordance with the Langelier saturation index within a range of -0.2 to + 0.2 to ensure that it is not corrosive or scale forming;
 - d. That is not salt water (other than mild saline water conditions which are compatible with swimming pool salt water chlorination systems) – unless otherwise stated by Waterco in both the respective product labels and brochures that it is suitable for seawater applications; and
 - e. That has been regularly treated with a sanitizing system using bromine, chlorine in one of its compound forms, or generated in-situ, in concentrations (doses) recommended by the relative state or territory health departments. (In areas outside of Australia please refer to the local health department recommendations before use);
7. Electrical equipment has been adequately protected from salt air environments and from salt water; and
All repairs and replacements shall be carried out by Waterco or its authorized service dealer, unless otherwise authorized in writing by Waterco.
If an authorized service dealer is not available within 25 km (15 miles) of the purchaser's area:
 - The purchaser must contact the place of purchase or Waterco for further instructions and;
 - The purchaser is responsible for any freight or infield labour costs.

EXCLUSIONS

This warranty does not cover, and Waterco will not be responsible for, any defect or damage caused or contributed to by:

- a. installation or use of the product other than in accordance with Waterco's written instructions,
- b. any statutory requirements and these terms and conditions;
- c. use of the product for a purpose other than for which it was designed or sold;
- d. abuse, misuse, corrosion, internal and external, or normal wear and tear;
- e. any repairs or modifications whatsoever carried out by any person, other than a Waterco authorized service dealer;
- f. exposure to water not caused by a defect in the product; and
- g. transit of the product over which Waterco has no control.
- h. inadequate ventilation
- i. cement, pebbles, render or other pool surface finishes blocking the pump's impeller
- j. insect and/or vermin infestation

Some three phase pumps are not supplied with thermal overload protection. It is the purchaser's responsibility to have this provision installed by appropriately licensed electricians prior to the initial installation of the pump. All electrical work must comply with any appropriate statutory requirements.

Warranty for installation of thermal overload protection is the sole responsibility of the licensed electrical contractor and not Waterco.

LIMITATIONS OF LIABILITY

To the extent permitted by law Waterco excludes all liability it may have to the purchaser for indirect, special or consequential loss arising from or related to any defect in any Waterco product, or any act or omission, including negligence of Waterco, including, but not limited to, loss of business, loss of profit, loss of revenue, lost opportunity, inconvenience, and damage to any property other than the Waterco product.

To the extent permitted by law, Waterco excludes all other conditions, guarantees, liabilities or representations that are not expressly set out in this agreement. These terms and conditions do not attempt to exclude, restrict or modify any applicable statutory rights, or any exercise of any statutory rights, or any liability imposed on Waterco by any law (including the Competition and Consumer Act 2010), if to do so would contravene that law or make any part of these terms and conditions void.

To the extent permitted by law, Waterco excludes all conditions and warranties implied into these terms and conditions and limits its liability for breach of any such condition or warranty that it cannot exclude to the greater of (at Waterco's option);

(a) for goods:

- Repairing or replacing those goods; or
- Paying the cost of having those goods repaired or replaced; and

(b) for services:

- Resupplying the services; or
- Paying the cost of having those services resupplied.

TEST YOUR WATER REGULARLY

The chemical balance of the water is a relationship between total alkalinity, pH, Calcium hardness and temperature. Waterco recommends that you have your water tested regularly by your local pool professional. A record of testing should always be kept for reference.

Some jurisdictions do not allow the exclusion or limitation of incidental or consequential damages, so any such limitation may not apply.

This warranty gives specific legal rights. The purchaser may have other rights depending on the jurisdiction in which the Waterco product was purchased or the purchaser is located.

SCHEDULE OF WARRANTY PERIODS

All products sold by Waterco are covered by a one year warranty with the exception of the products listed below.

- Aquamaster Pool and Spa Automation – Domestic use – 2 years
- Aquamaster Pool and Spa Automation – Commercial use – 1 year

Glossary of Terms

Interlock

The interlock feature ensures that the filtration pump is operating prior to allowing another system component to operate.

Interlink

The interlink feature allows the user to operate two or more functions together. Select the “Interlink” button and then select the function required to operate with the relevant output.

Integrated Conventional Heater

“Integrated” should be selected for a conventional heater operating within the filtration circuit.

Independent Conventional Heater

“Independent” should be selected for a conventional heater operating separately to the filtration circuit.

Heater Timer

The “Heater Timer” button allows timer control parameters to be set for the conventional heater.

Heating Demand Option

If “Heating Demand Opt” is selected the conventional heater will continue to operate until the set temperature is reached overriding any filtration timers.

Set Demand Mode Timer

The “Set Demand Mode Timer” button allows timer control parameters to be set if the “Heating Demand Opt” is selected.

Integrated Solar

“Integrated” should be selected for a solar system operating within the filtration circuit.

Independent Solar

“Independent” should be selected for a solar system operating separately to the filtration circuit.

Solar Temp Check Period

The Solar Temperature check period for systems with solar heater demand enabled can be adjusted; otherwise the check delay is set for 2 Hours.

Solar Preference

The “Solar Preference” feature should be selected if the solar heating is to have operational priority over a conventional heater.

Solar Demand Option

The “Solar Demand Opt” feature should be selected if the solar heating is to continue to operate while there is solar gain overriding any filtration timers.

Select Solar Output

The “Select Solar Output” feature allows water control selection to the solar system via either a Solar Pump or Solar Valve.

Freeze Protection

Freeze protection is used to protect the pool hydraulics and plumbed equipment against freeze damage. If freeze protection is enabled and the AIR temperature falls below 3oC, Aquamaster will turn on the filter pump to circulate the water. If in “Pool and Spa” mode the valves will also alternate between the pool and spa every 30 minutes.

For service enquiries please contact your installer or:

Waterco Limited.
36 South Street
Rydalmere, NSW 2116
P: 02 9898 8600
F: 02 9898 1877
E: administration@waterco.com