

**LORENTZ** 

# **S1-700**

**Solar Pump System**

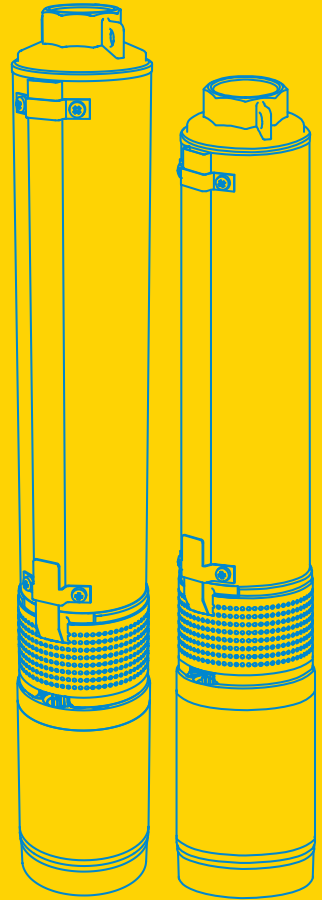
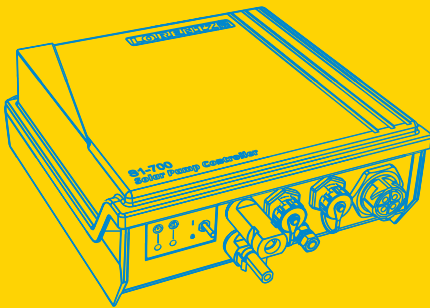

**SOLAR WATER PUMPING MADE SIMPLE**

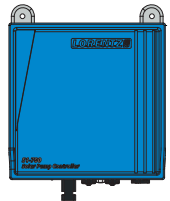
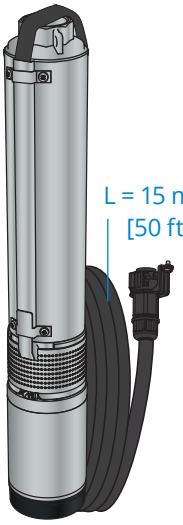
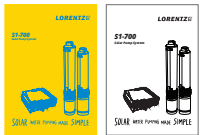

	
<b>S1-700 - C</b>	
	x 1
 L = 15 m [50 ft]	x 1
	x 1

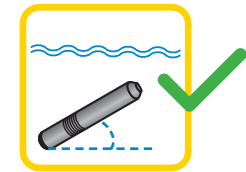
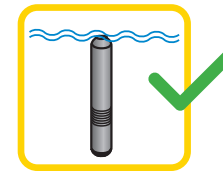
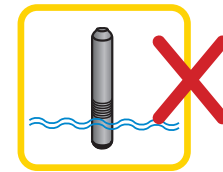

min.  $\Delta$  30°

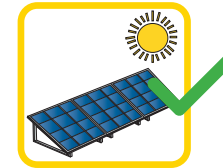
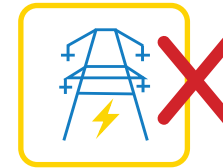

min. Vmp 60 V DC  
min. best performance  
Vmp 95 V DC  
max. Voc 220 V DC



IP 68

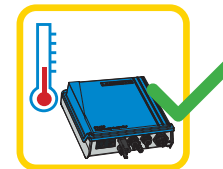
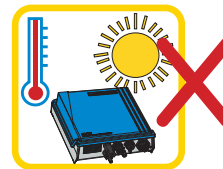

max. 45 °C [113 °F]

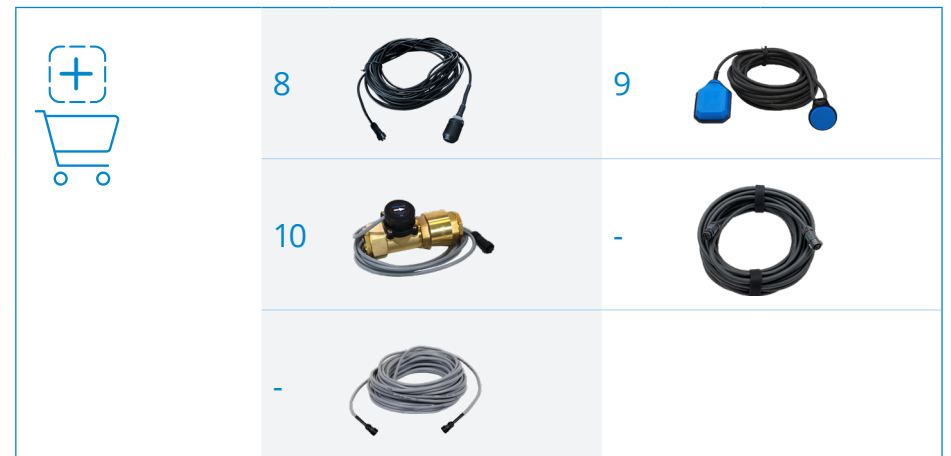
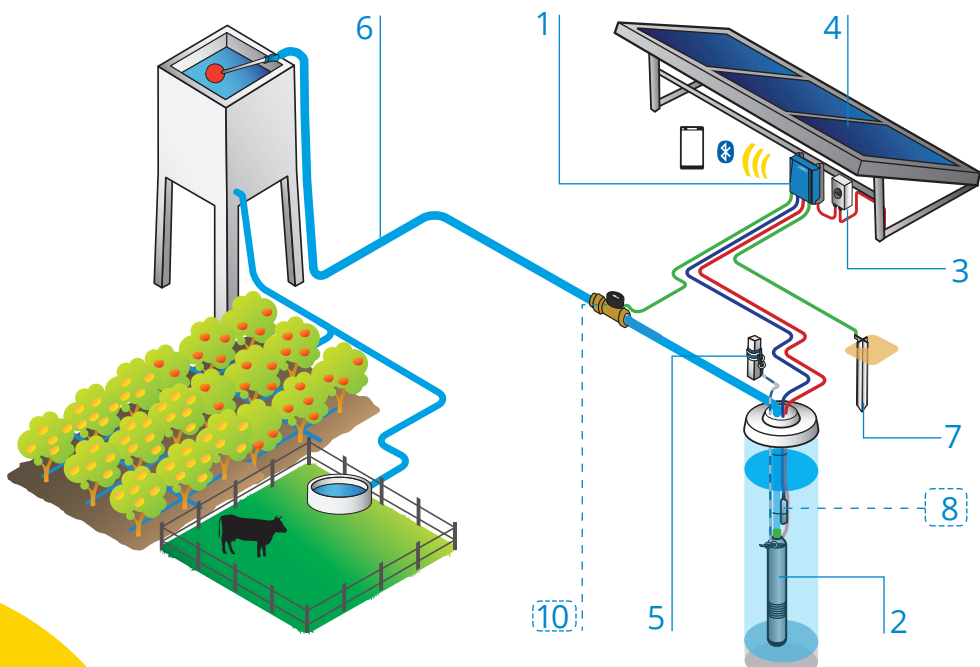
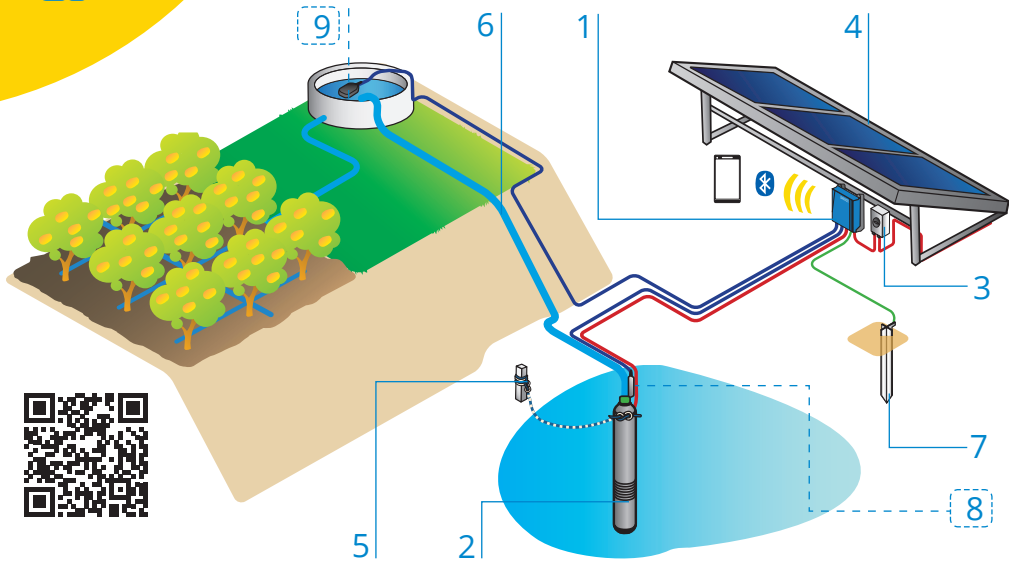

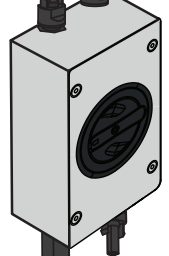
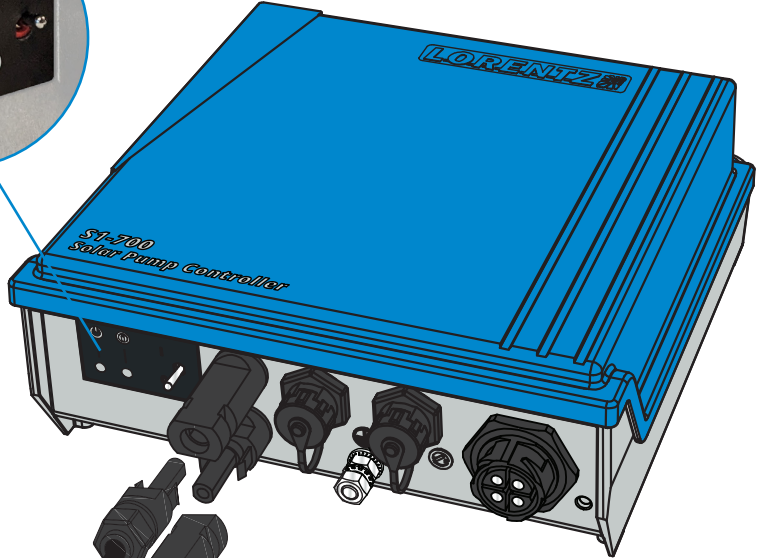
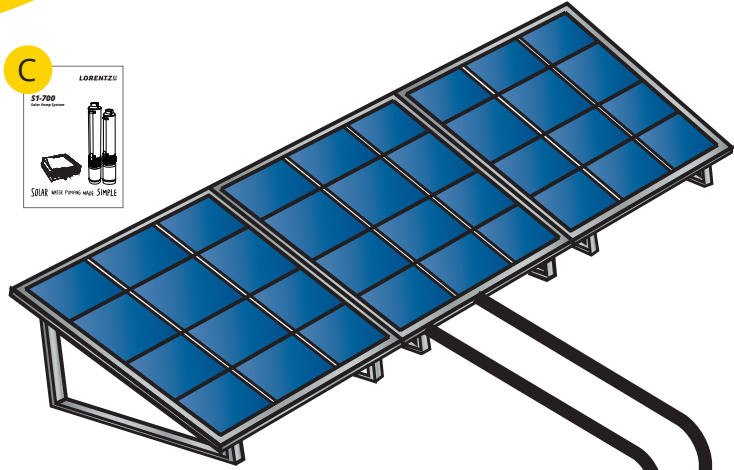

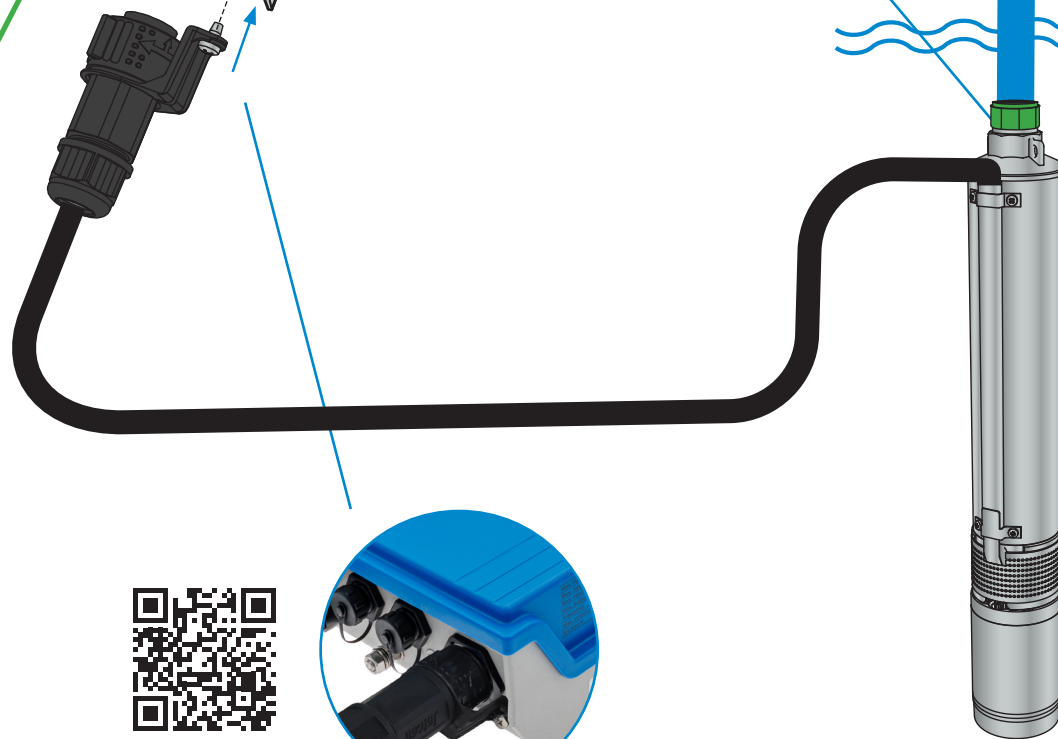
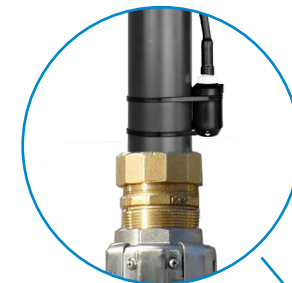
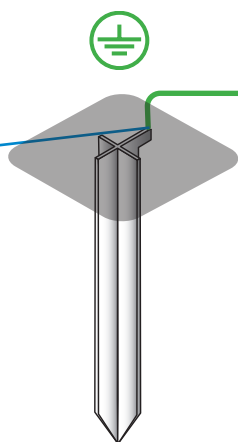
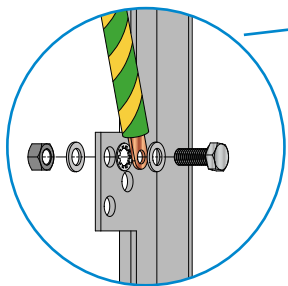
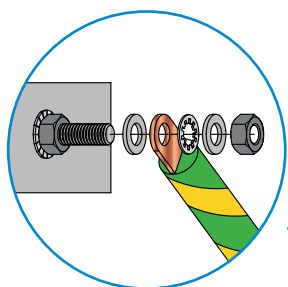
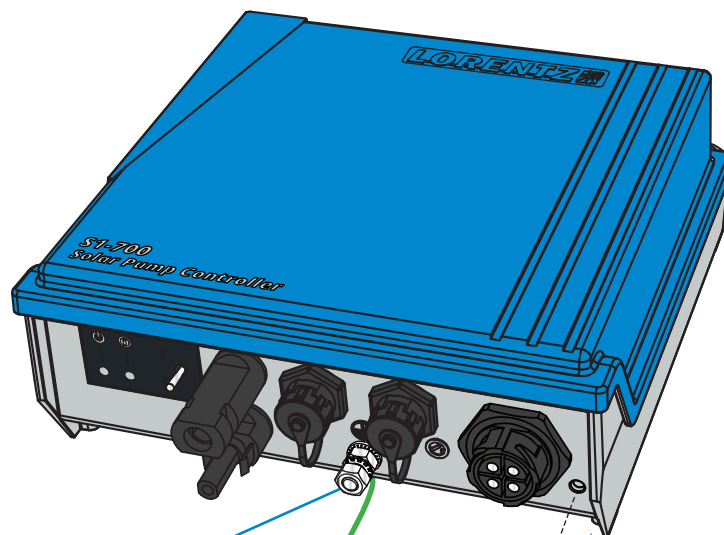



175 mm (6.8")

Ø 6.4 mm [0.25"]

Ø 34.5 mm [1.35"]

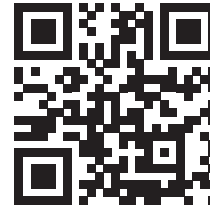
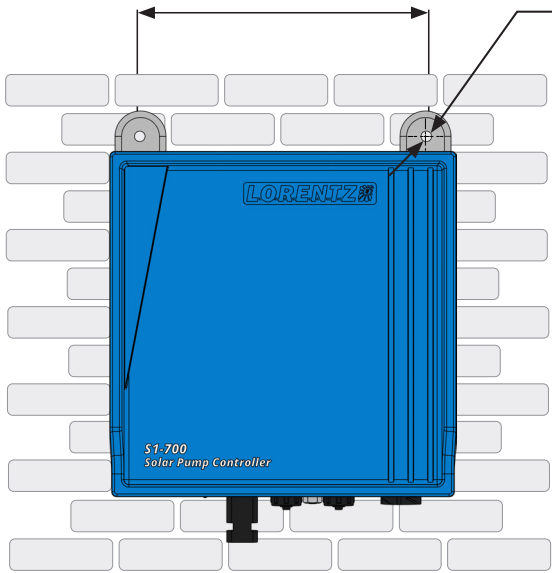

LORENTZ  
S-Connect

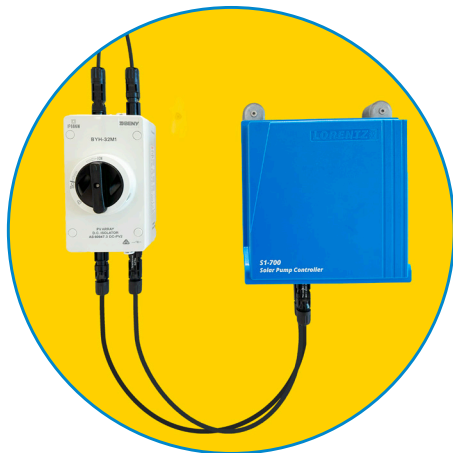
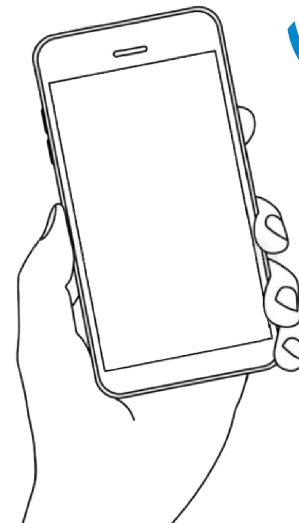
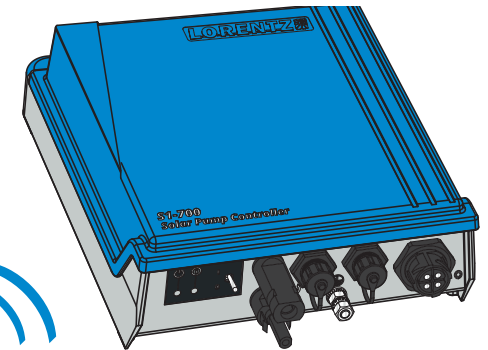

[www.lorenz.de/shelp](http://www.lorenz.de/shelp)

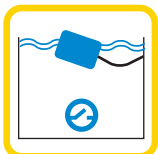
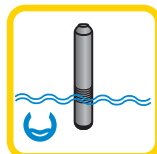
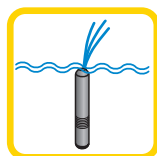
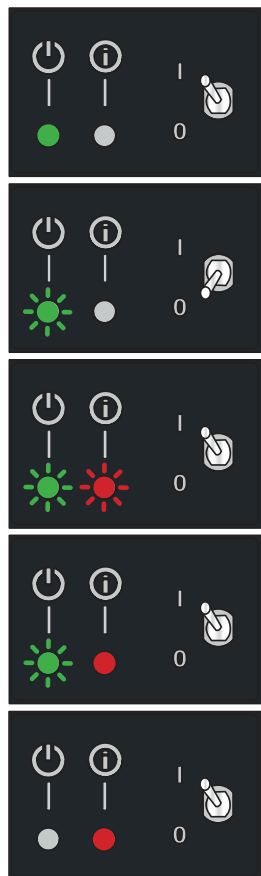

### Actual data

Input voltage	97.8 V
Input current	7.6 A
Power	744 W
Temperature	38.8 °C
Motor speed	3142 rpm
Flow	5.96 m³/h

### Operational status

- OK

### Settings

Pump end selector	CST-4-6
Total dynamic head	10 m
Dry Run Protection Switch	Deactivated
Tank Full Switch	Deactivated

### Version info

Serial number	90810049
Controller HW version	0.6
Controller SW version	0.0.0
Type	S1-700
Version	Ver...



### Advanced

Pump end selector

CST-4-6

CST-4-6

CST-2-10

Dry Run Protection Switch

Tank Full Switch



**Dry Run Protection**  
 15 m / 50 ft  
 Item# 19-001560

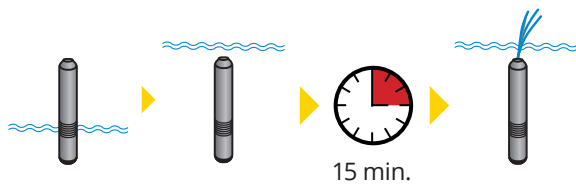
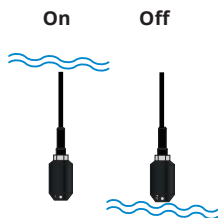
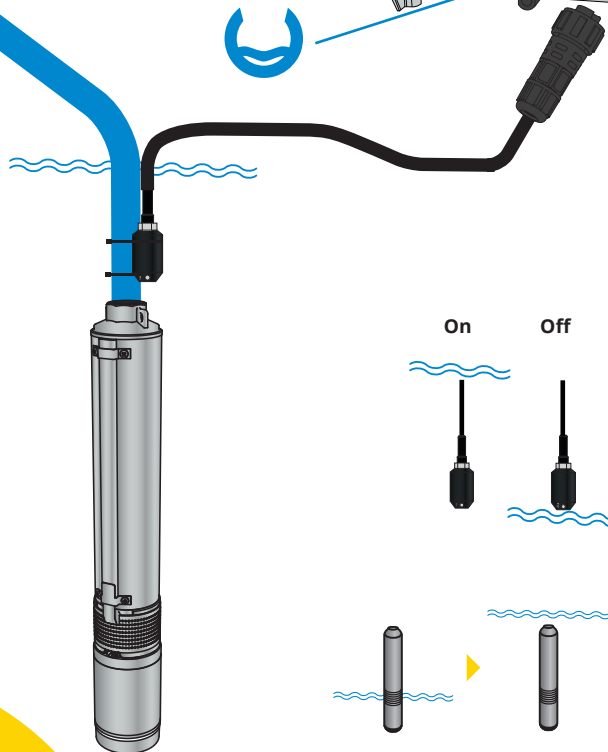
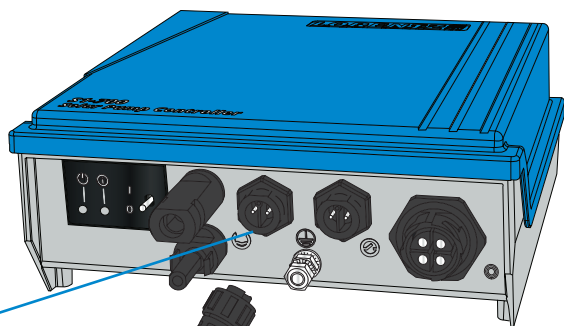

**S1-700 Motor Extension Cable**  
 20 m / 66 ft  
 Item# 19-005600

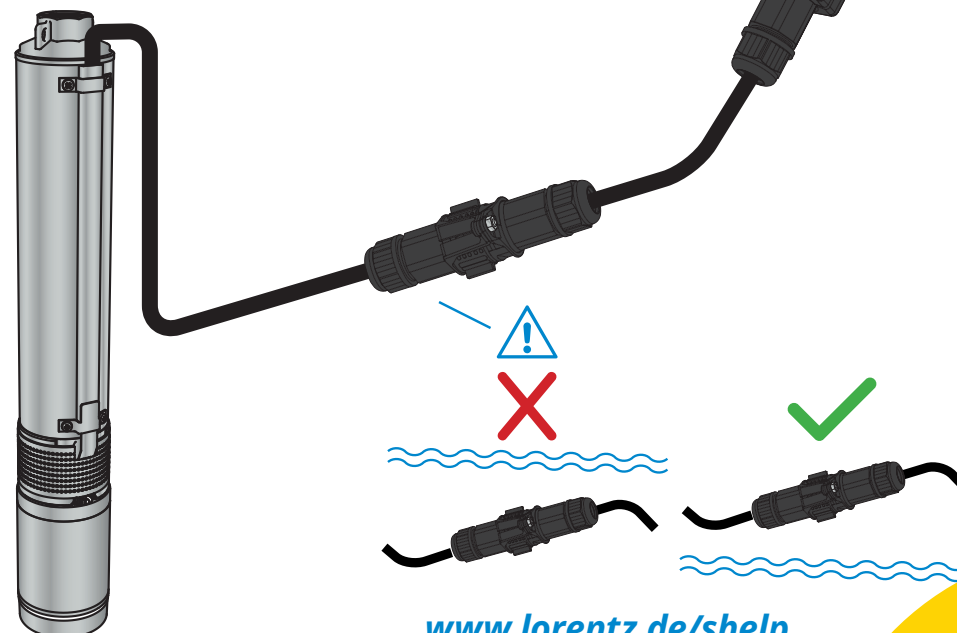
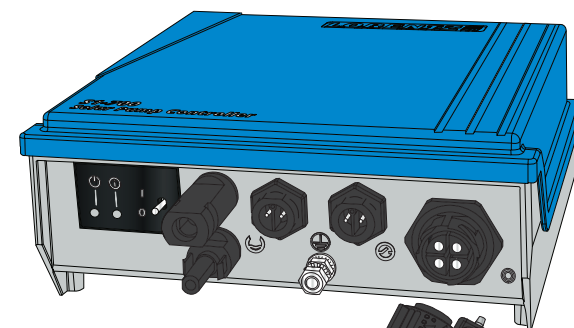
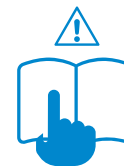



**Tank Full Switch**  
 10 m / 32 ft  
 Item# 19-001550

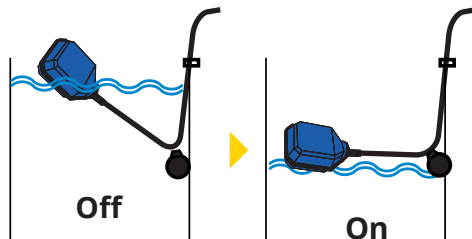
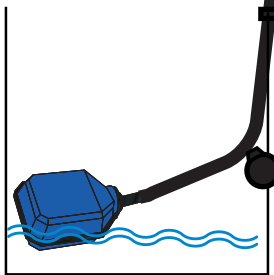
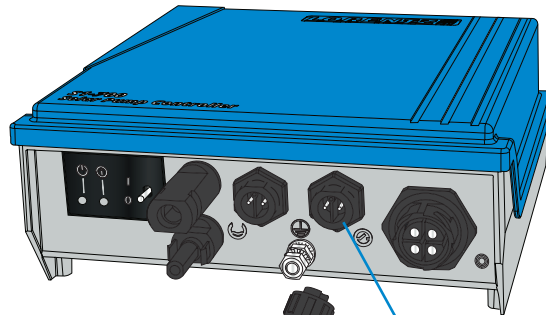
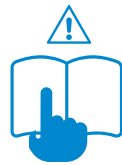

**S1-700 remote tank switch**  
 3 m / 10 ft cable  
 Item # 19-001640

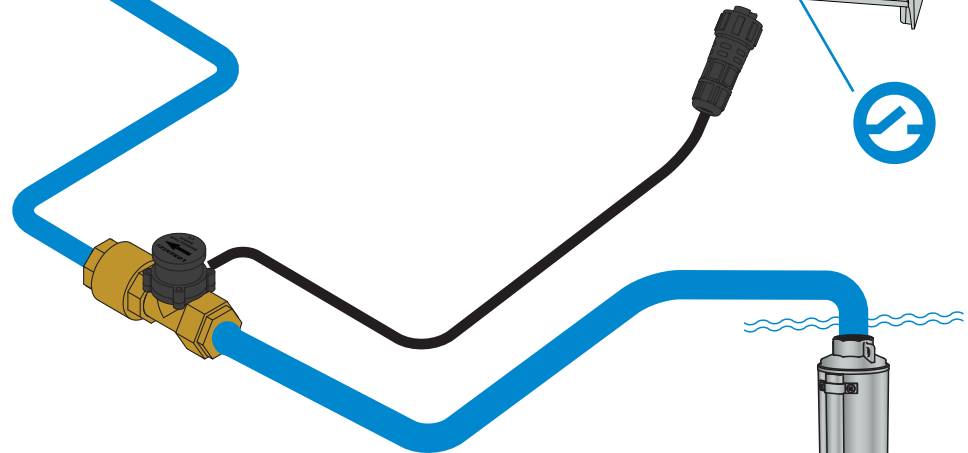
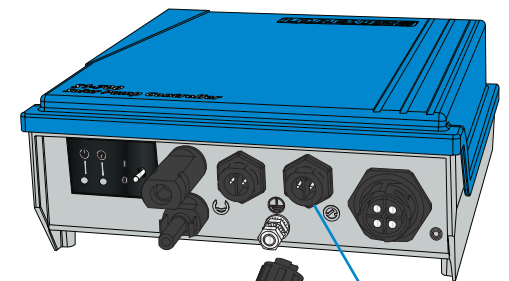
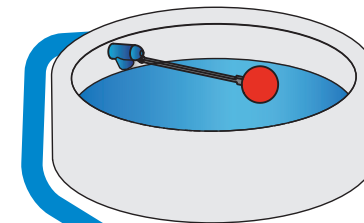
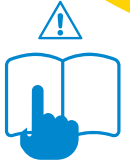



### Accessory Extension Cable

20 m / 66 ft  
Item# 19-001575

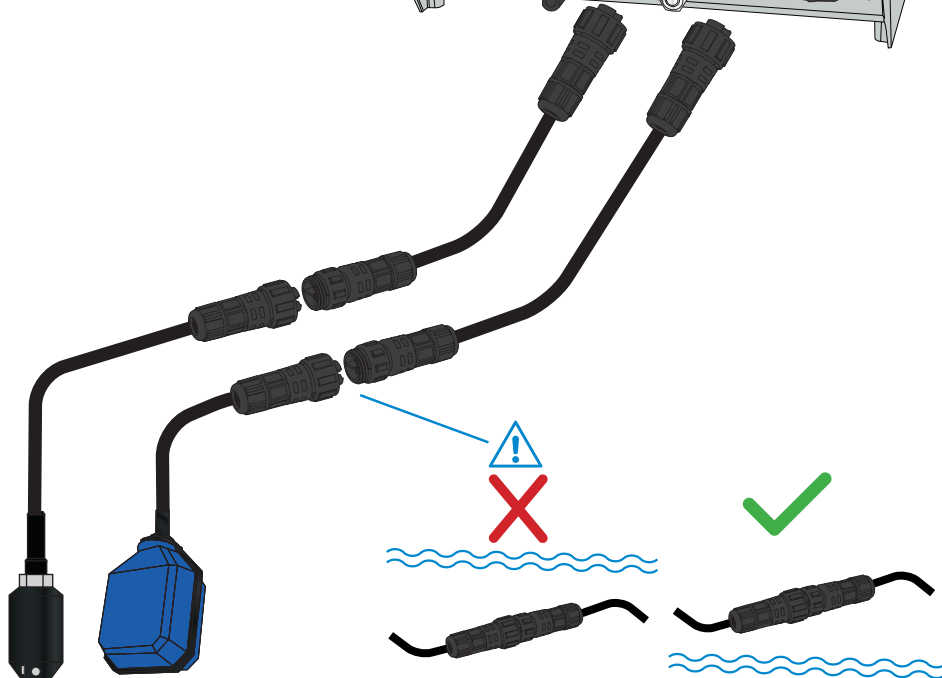
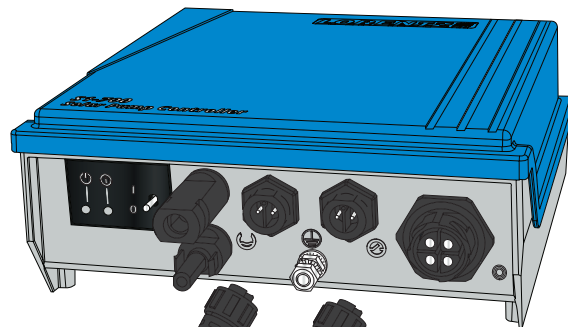



## About LORENTZ

**LORENTZ is the global market leader in solar powered water pumping solutions.**

Founded in Germany during 1993 LORENTZ has pioneered, innovated and excelled in the engineering and manufacturing of solar powered water pumping. Today LORENTZ is active in over 130 countries through a dedicated network of professional partners.

**LORENTZ S product range is specially designed to bring solar pumping to the widest audience.**

LORENTZ S products take the experience, quality, reliability and efficiency of the world leading solar pumps and simplifies them for self installation.

# SOLAR WATER PUMPING MADE SIMPLE



LORENTZ Germany  
Siebenstücken 24  
24558 Henstedt-Ulzburg  
Germany

[www.lorentz.de/shelp](http://www.lorentz.de/shelp)