

LORENTZ 

S1-200

Solar Pump System

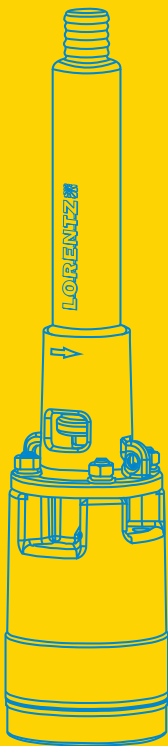
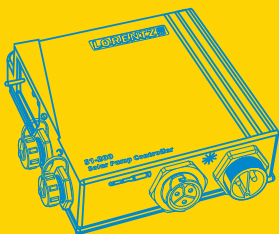

SOLAR WATER PUMPING MADE **SIMPLE**



1 x



1 x



1 x

L = 15 m [50 ft]



2 x



1 x

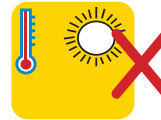
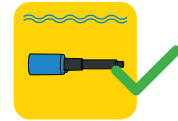
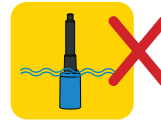

min. V_{mp} 24 V DC
min. best performance
V_{mp} 45 V DC
max. V_{oc} 55 V DC

max. 50°C / 122°F

IP 68

- 1 = 10... 20 °C [50... 68 °F]
- 2 = 20... 30 °C [68... 86 °F]
- 3 = 30... 40 °C [86... 104 °F]
- 4 = 40... 50 °C [104... 122 °F]

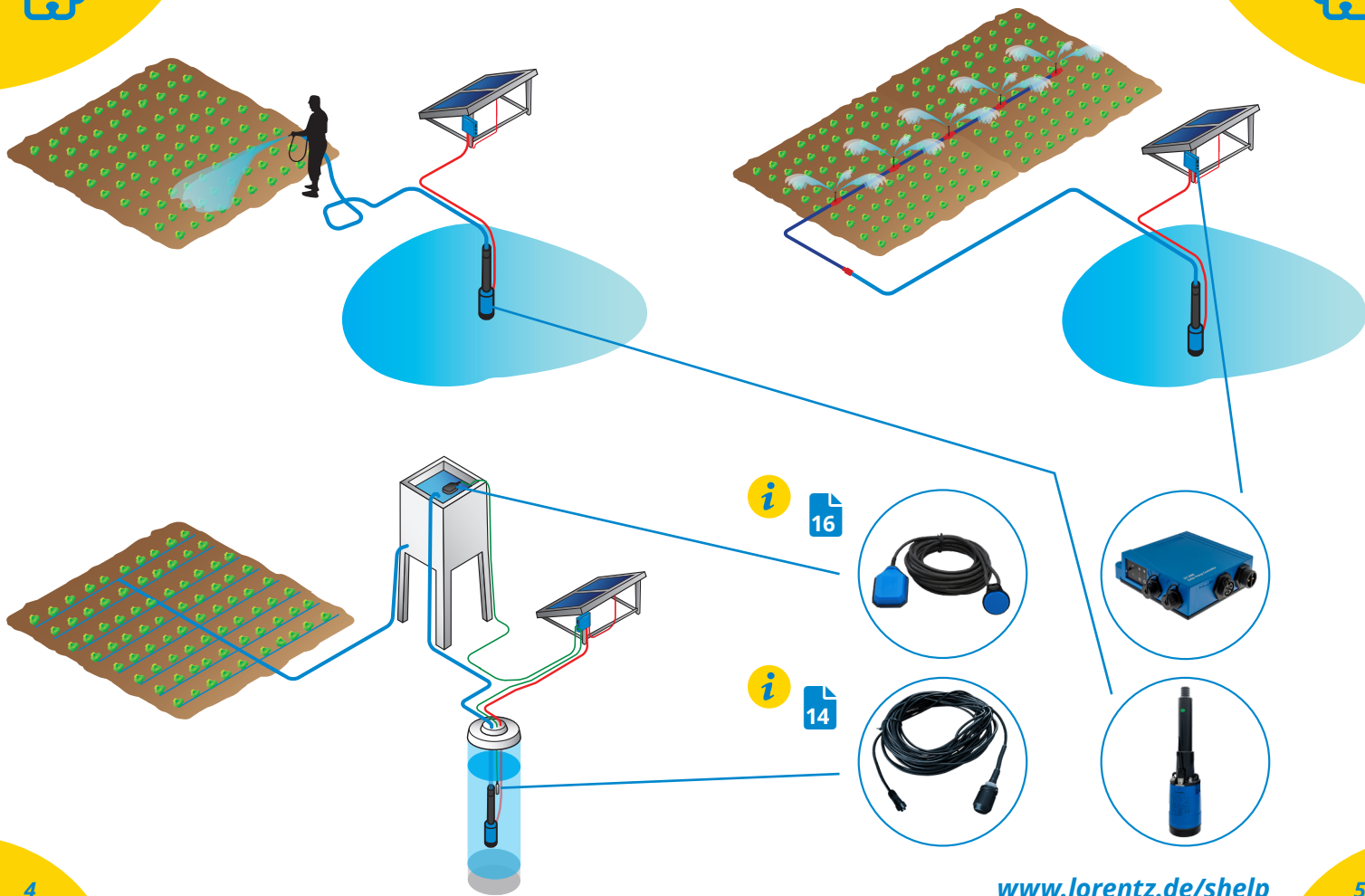



D

LORENTZ

S1-200

Water pump controller
 12V DC
 200W
 12V DC
 200W

SOLAR PUMP SYSTEM MADE SIMPLE

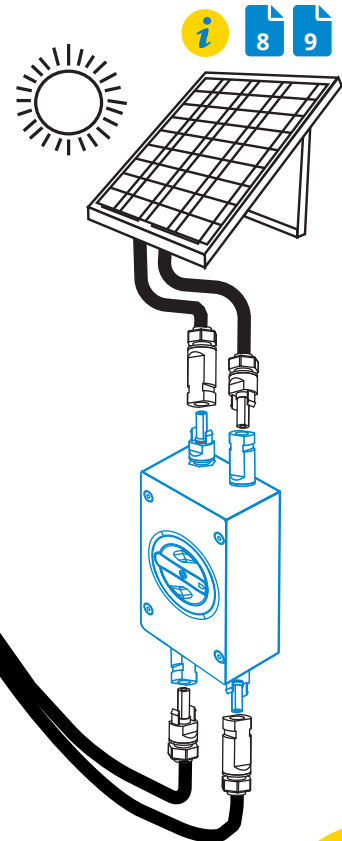
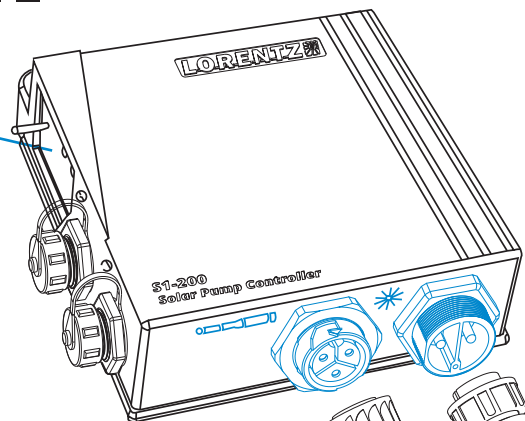
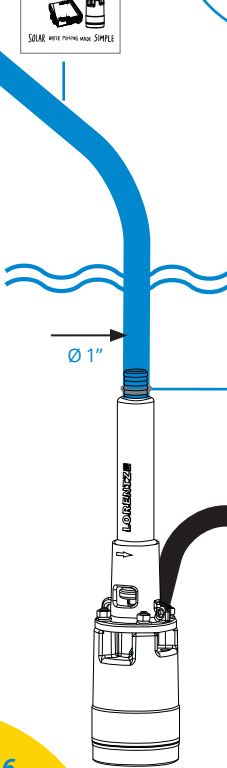

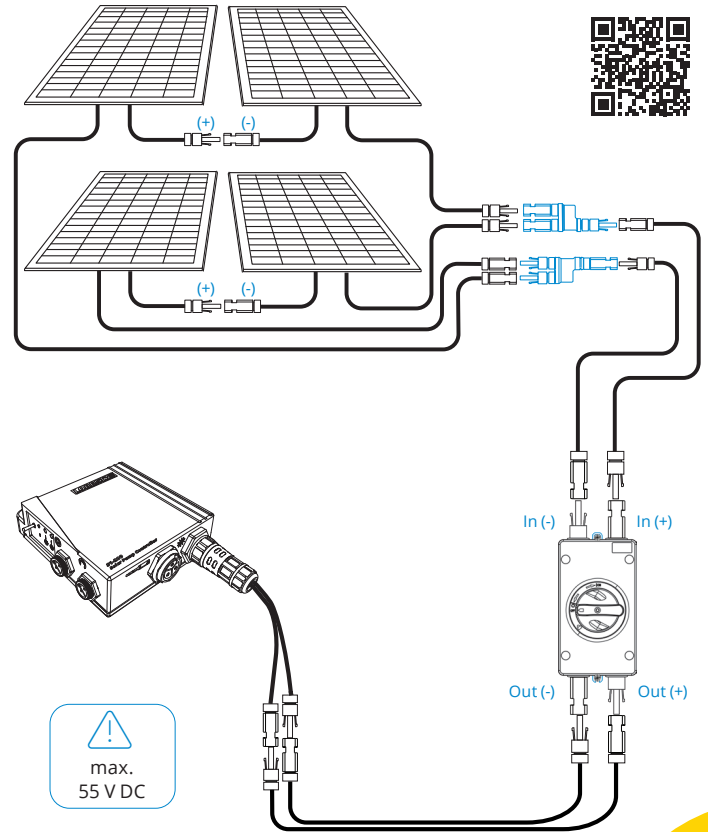
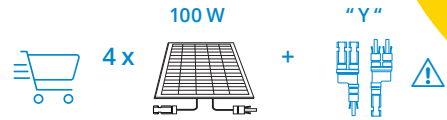
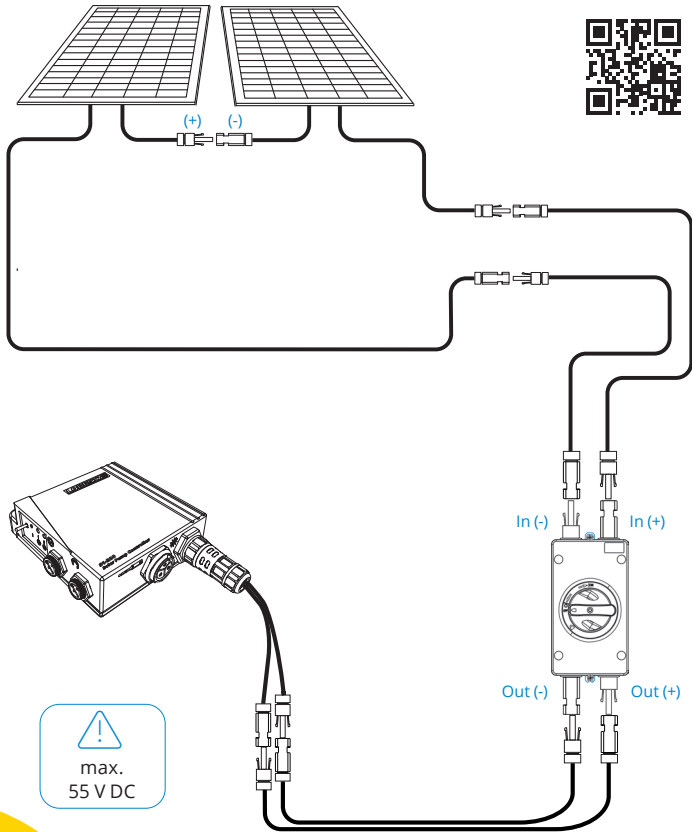
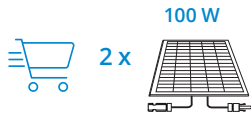

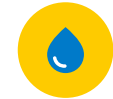
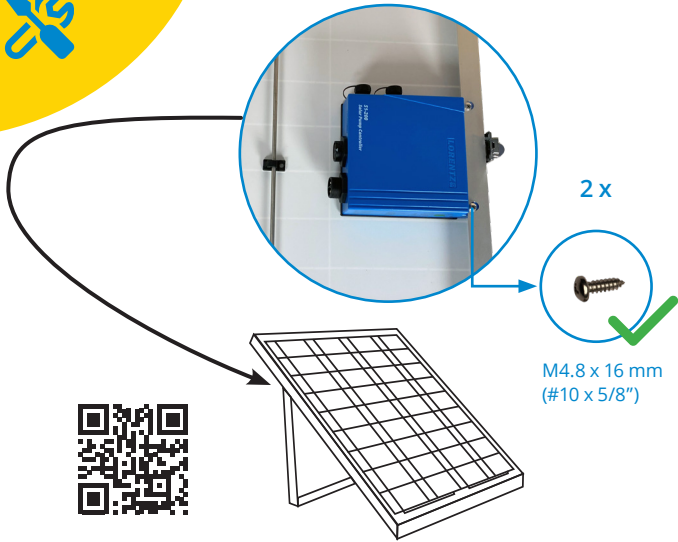

LORENTZ
S-Connect

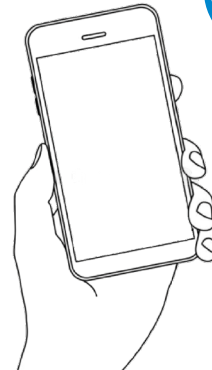
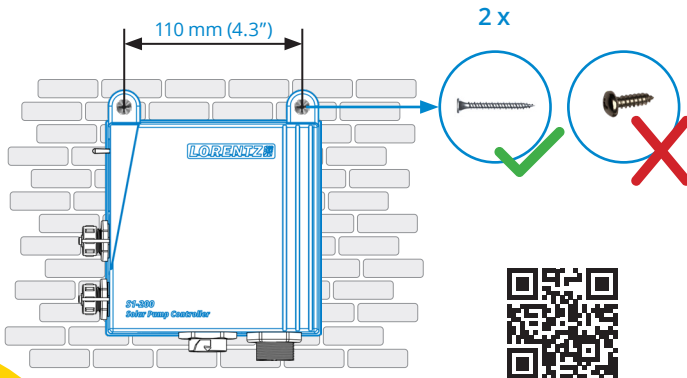
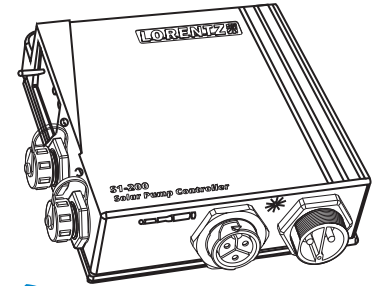

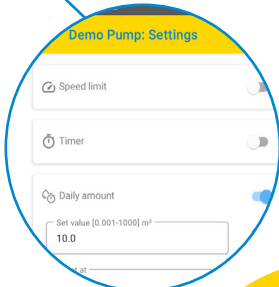
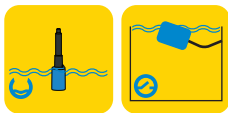
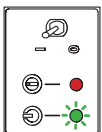
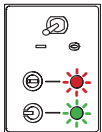
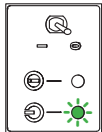
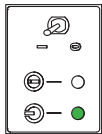
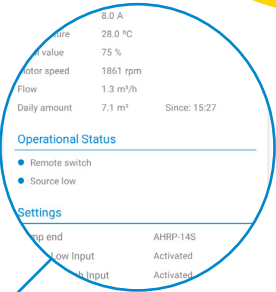
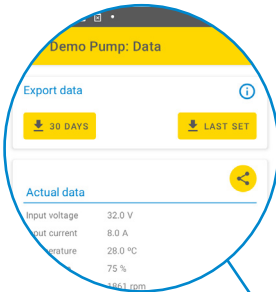



Dry Run Protection
15 m / 50 ft
Item# 19-001560

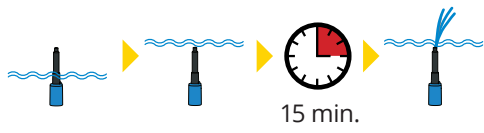
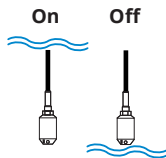
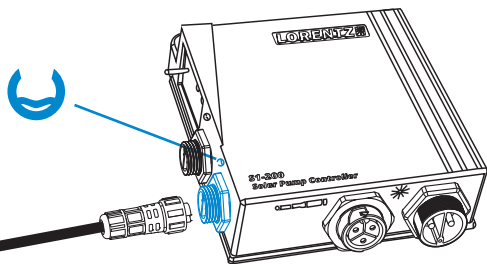

Accessory Extension Cable
20 m / 65 ft
Item# 19-001575

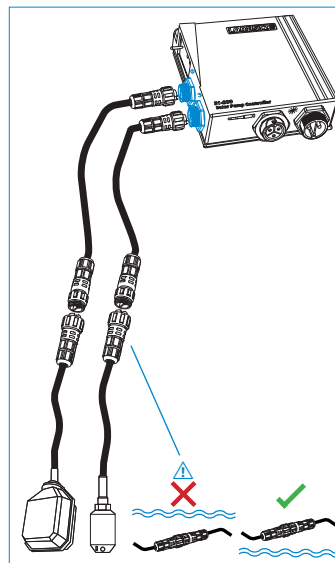

Motor Extension Cable
20 m / 65 ft
Item# 19-001585

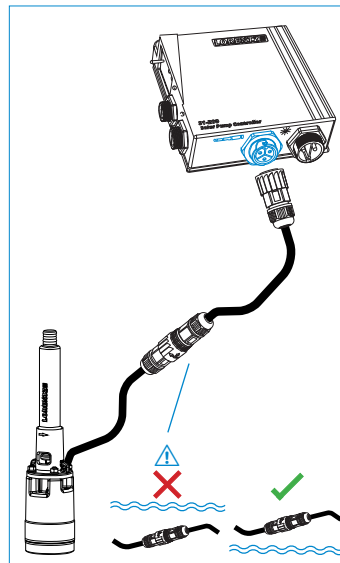



Tank Full Switch
10 m / 32 ft
Item# 19-001550

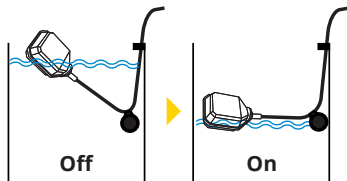
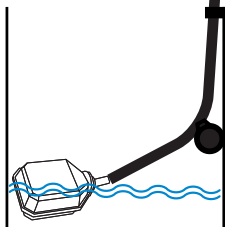
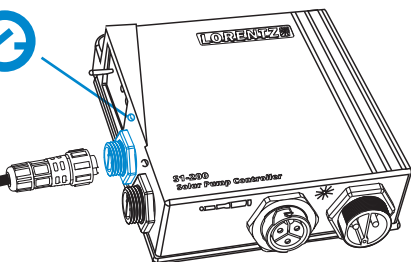

S1-200 remote tank switch
with 3 m / 10 ft cable
Item # 19-001530

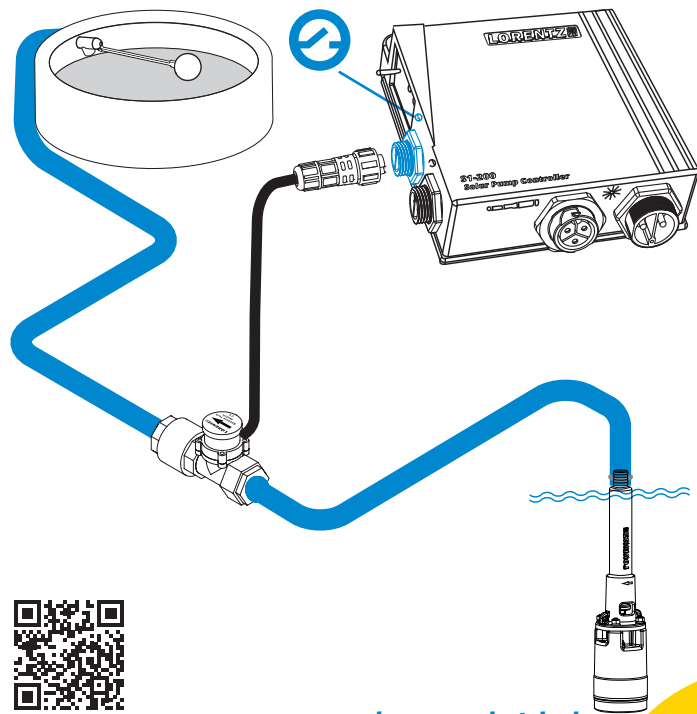
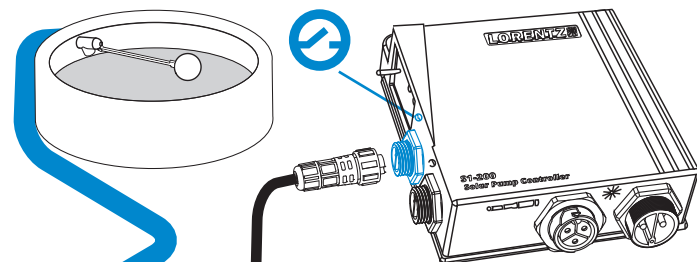





About LORENTZ

LORENTZ is the global market leader in solar powered water pumping solutions.

Founded in Germany during 1993 LORENTZ has pioneered, innovated and excelled in the engineering and manufacturing of solar powered water pumping. Today LORENTZ is active in over 130 countries through a dedicated network of professional partners.

LORENTZ S product range is specially designed to bring solar pumping to the widest audience.

LORENTZ S products take the experience, quality, reliability and efficiency of the world leading solar pumps and simplifies them for self installation.

SOLAR WATER PUMPING MADE SIMPLE



LORENTZ Germany
Siebenstücken 24
24558 Henstedt-Ulzburg
Germany

www.lorentz.de/shelp