

BL100 • BL101

pH & ORP Pump Controllers



INSTRUCTION MANUAL

 **HANNA**[®]
instruments

Dear
Customer,

Thank you for choosing a Hanna Instruments[®] product.
Please read this instruction manual carefully before using this instrument.
This manual will provide you with the necessary information for correct use of this instrument, as well as a precise idea of its versatility.
If you need additional technical information, do not hesitate to e-mail us at tech@hannainst.com or view our worldwide contact list at www.hannainst.com.

All rights are reserved. Reproduction in whole or in part is prohibited without the written consent of the copyright owner, Hanna Instruments Inc., Woonsocket, Rhode Island, 02895, USA.

TABLE OF CONTENTS

1. Preliminary Examination 4

2. Safety Measures 6

3. Abbreviations & Conversion Charts 6

4. Specifications 7

 4.1. BL100 pH Controller..... 7

 4.2. BL101 ORP Controller..... 8

 4.3. pH & ORP Probe Specifications..... 9

5. Description..... 10

 5.1. General Description & Intended Use..... 10

 5.2. Functional & Display Description 12

6. Installation 17

7. Setup 24

8. Priming the Pump..... 31

 8.1. Automatic Control Types..... 31

 8.2. Priming the Pump..... 32

9. Events Management 33

 9.1. Alarms..... 33

 9.2. Warnings 34

 9.3. Summary of General Behavior..... 34

10. Calibration..... 35

 10.1. pH Calibration (BL100 only)..... 35

 10.2. Process pH & ORP Calibration 37

 10.3. Clear Calibration 39

11. Measurement..... 40

12. Error Messages..... 41

13. Maintenance 42

 13.1. Electrode Conditioning & Maintenance..... 42

 13.2. Pump Tubing Replacement..... 42

14. Accessories..... 44

Certification..... 46

Recommendations for Users..... 46

Warranty 46

1. PRELIMINARY EXAMINATION

Remove the instrument and accessories from the packaging and examine it carefully. For further assistance, please contact your local Hanna Instruments® office or email us at tech@hannainst.com.

Each instrument is delivered in a cardboard box and supplied with:

pH model

BL100-00, without mounting kit

- HI10053 pH/temperature probe
 - 4.01 pH Buffer solution, 20 mL (3 pcs.)
 - 7.01 pH Buffer solution, 20 mL (3 pcs.)
 - Power connection cable
 - Instrument & electrode quality certificates
 - Instruction manual
-

BL100-10, with in-line mounting kit

- HI10053 pH/temperature probe
 - Pool controller aspiration filter
 - Pool controller injector, ½" NPT thread
 - Saddle for Ø 50 mm pipe (2 pcs.)
 - 4.01 pH buffer solution, 20 mL (3 pcs.)
 - 7.01 pH buffer solution, 20 mL (3 pcs.)
 - Power connection cable
 - Instrument & electrode quality certificates
 - Instruction manual
 - Aspiration and injection tubing, PVC
Length: 10 m
Outer diameter: 6.0 mm
Inner diameter: 4.0 mm
-

BL100-20, with flow cell mounting kit

- HI10053 pH/temperature probe
 - Flow cell for BL100/BL101
 - Mounting panel assembly for BL100/BL101
 - Pool controller aspiration filter
 - Pool controller injector, ½" NPT thread
 - Saddle for Ø 50 mm pipe (3 pcs.)
 - 4.01 pH buffer solution, 20 mL (3 pcs.)
 - 7.01 pH buffer solution, 20 mL (3 pcs.)
 - Power connection cable
 - Instrument & electrode quality certificates
 - Instruction manual
 - Rapid coupling ½" to 12 mm (2 pcs.)
 - Flow cell valve (2 pcs.)
 - Aspiration and injection tubing, PVC
Length: 10 m
Outer diameter: 6.0 mm
Inner diameter: 4.0 mm
 - Flow cell tubing, PE (rigid)
Length: 10 m
Outer diameter: 12.0 mm
Inner diameter: 10.0 mm
-

ORP model

BL101-00, without mounting kit

- HI20083 ORP/temperature probe
 - ORP test solution (3 pcs.)
 - Power connection cable
 - Instrument & electrode quality certificates
 - Instruction manual
-

BL101-10, with in-line mounting kit

- HI20083 ORP/temperature probe
 - Pool controller aspiration filter
 - Pool controller injector, ½" NPT thread
 - Saddle for Ø 50 mm pipe (2 pcs.)
 - ORP test solution (3 pcs.)
 - Power connection cable
 - Instrument & electrode quality certificates
 - Instruction manual
 - Aspiration and injection tubing, PVC
Length: 10 m
Outer diameter: 6.0 mm
Inner diameter: 4.0 mm
-

BL101-20, with flow cell mounting kit

- HI20083 ORP/temperature probe
 - Flow cell for BL100/BL101
 - Mounting panel assembly for BL100/BL101
 - Pool controller aspiration filter
 - Pool controller injector, ½" NPT thread
 - Saddle for Ø 50 mm pipe (3 pcs.)
 - ORP test solution (3 pcs.)
 - Power connection cable
 - Instrument & electrode quality certificates
 - Instruction manual
 - Quick tubing fitting ½" to 12 mm (2 pcs.)
 - Flow cell valve (2 pcs.)
 - Aspiration and injection tubing, PVC
Length: 10 m
Outer diameter: 6.0 mm
Inner diameter: 4.0 mm
 - Flow cell tubing, PE (rigid)
Length: 10 m
Outer diameter: 12.0 mm
Inner diameter: 10.0 mm
-

Note: Save all packing material until you are sure that the instrument works correctly. Any damaged or defective item must be returned in its original packing material with the supplied accessories.

2. SAFETY MEASURES



- Do not use chlorine tablets, granular chlorine or other non-liquid chlorine applications.
- Do not use the pump controller in a pool utilizing electrolytic chlorine generation (salt electrolysis).



- Do not add stabilizer (e.g. cyanuric acid) to the swimming pool while using the pump controller. To remove stabilizer from the pool, the pool must be drained and cleaned.



- Always disconnect the pump controller from power when making electrical connections.
- Do not run other cables with the power cabling.
- Do not touch the metallic part. Hot surface.

3. ABBREVIATIONS & CONVERSION CHARTS

FDA	Food and Drug Administration	PVC	Polyvinyl Chloride
NPT	American National Standard Taper Pipe Thread	ORP	Oxidation-Reduction Potential
LED	Light Emitting Diode	REDOX	Reduction & Oxidation
PE	Polyethylene	SPDT	Single Pole Double Throw

METRIC vs INCHES

Metric (mm)	Inches - Decimal	Inches - Fractional
4.0 mm	0.16"	$\frac{5}{32}$ "
6.0 mm	0.24"	$\frac{15}{64}$ "
10.0 mm	0.39"	$\frac{25}{64}$ "
12.0 mm	0.47"	$\frac{15}{32}$ "
20.0 mm	0.79"	$\frac{25}{32}$ "
25.4 mm	1.00"	1"
50.0 mm	1.97"	$1 \frac{31}{32}$ "
63.0 mm	2.48"	$2 \frac{31}{64}$ "
75.0 mm	2.95"	$2 \frac{61}{64}$ "

METRIC vs FEET & INCHES

Metric (m)	Feet (') Inches (")	Feet (')	Inches (")
2 m	6' 7"	6.56'	78.74"
5 m	16' 4"	16.40'	196.85"
10 m	32' 9"	32.80'	393.70"

4. SPECIFICATIONS

4.1. BL100 pH CONTROLLER

Range	0.00 to 14.00 pH * -5.0 to 105.0 °C (23.0 to 221.0 °F)*
Resolution	0.01 pH 0.1 °C (0.1 °F)
Accuracy @ 25 °C / 77 °F	±0.10 pH ±0.5 °C (±0.9 °F)
Calibration	<ul style="list-style-type: none"> • User calibration: automatic, one or two-point with buffer solution (4.01, 7.01, 10.01 pH) • Process calibration: single point, adjustable (±0.50 pH around measured pH)
Temperature Compensation	Automatic
High or Low Mode Operation	<ul style="list-style-type: none"> • On/Off control using adjustable set point (6.00 to 8.00 pH) with adjustable hysteresis (0.10 to 1.00 pH) • Proportional control using adjustable set point (6.00 to 8.00 pH) with adjustable proportional band (0.10 to 2.00 pH) • Startup delay timer at power-on (0 to 600 sec.)
Pump Control	<ul style="list-style-type: none"> • Pump flow control 0.5 to 3.5 Liter/hour (0.13 to 0.92 Gallon/hour) and maximum output pressure 1 atm (14 psi) • Manual control for pump priming (defined in setup)
pH Alarms	<ul style="list-style-type: none"> • High & Low with enable or disable option • Triggered after 5 sec. if the controller records consecutive readings over or under threshold values • Level with enable or disable option • Overtime protection (1 to 180 min. or Off)
Controller Alarm System	<ul style="list-style-type: none"> • Intuitive alarm system, using red, light-green and green color coded backlight • User-selectable, alarm setup options
Alarm Relay Output	<ul style="list-style-type: none"> • SPDT 2.5A / 230 Vac • Activated by pH-selectable alarm conditions
Probe Input	<ul style="list-style-type: none"> • Quick connect DIN connector • Galvanic isolation
Level Sensor Input (Digital Input)	<ul style="list-style-type: none"> • External switches can be attached to stop the pump and activate the alarm (low reagent level) when the switch is open and level alarm is configured in Setup • Galvanic isolation

* The range may be limited by the probe's limits.

Power Supply	100 - 240 Vac, 50/60 Hz
Power Consumption	15 VA
Environment	0 to 50 °C (32 to 122 °F), max. 95% RH non-condensing
Dimensions	90 x 142 x 80 mm (3.5 x 5.6 x 1.8")
Weight	910 g (32 oz)
Casing	Wall mounted, built-in pump, IP65 rated

4.2. BL101 ORP CONTROLLER

Range	<p>–2000 to 2000 mV –5.0 to 105.0 °C (23.0 to 221.0 °F)* * The range may be limited by the probe's limits.</p>
Resolution	<p>1 mV 0.1 °C (0.1 °F)</p>
Accuracy @ 25 °C / 77 °F	<p>± 5 mV ± 0.5 °C (± 0.9 °F)</p>
Calibration	Process calibration: one-point, adjustable (± 50 mV around measured ORP)
High or Low Mode Operation	<ul style="list-style-type: none"> • On/Off control using adjustable set point (200 to 900 mV) with adjustable hysteresis (10 to 100 mV) • Proportional control using adjustable set point (200 to 900 mV) with adjustable proportional band (10 to 200 mV) • Startup delay timer at power-on (0 to 600 sec.)
Pump Control	<ul style="list-style-type: none"> • Pump flow control 0.5 to 3.5 Liter/hour (0.13 to 0.92 Gallon/hour) and maximum output pressure 1 atm (14 psi) • Manual control for pump priming (defined in setup)
ORP Alarms	<ul style="list-style-type: none"> • High & Low with enable or disable option • Triggered after 5 sec. if the controller records a set of consecutive readings over or under threshold values • Level with enable or disable option • Overtime protection (1 to 180 min. or Off)
Controller Alarm System	<ul style="list-style-type: none"> • Intuitive alarm system, using red, light-green and green color-coded backlight • User-selectable, alarm setup options
Alarm Relay Output	<ul style="list-style-type: none"> • SPDT 2.5A / 230 Vac • Activated by ORP selectable alarm conditions
Probe Input	<ul style="list-style-type: none"> • Quick connect DIN connector • Galvanic isolation

Level Sensor Input (Digital Input)	<ul style="list-style-type: none"> External switches can be attached to stop the pump and activate the alarm (low reagent level) when the switch is open and level alarm is configured in Setup Galvanic isolation
Power Supply	100 - 240 Vac, 50/60 Hz
Power Consumption	15 VA
Environment	0 to 50 °C (32 to 122 °F), max. 95% RH non-condensing
Dimensions	90 x 142 x 80 mm (3.5 x 5.6 x 1.8")
Weight	910 g (32 oz)
Casing	Wall mounted, built-in pump, IP65 rated

4.3. pH & ORP PROBE SPECIFICATIONS

Specifications	HI10053 (BL100)	HI20083 (BL101)
Range	0 to 12 pH	± 2000 mV
Reference	Double junction	Double junction
Junction	Cloth	Cloth
Temperature sensor	Yes	Yes
Temperature range	-5 to 70 °C (23 to 158 °F)	-5 to 70 °C (23 to 158 °F)
AmpHel [®]	Yes	Yes
Matching pin	Yes	Yes
Body	PVDF (blue)	PVDF (red)
Top thread	¾" NPT	¾" NPT
In-line mounting thread	½" NPT	½" NPT
Cable length	2 m	2 m
Connector	Quick connect DIN connector	Quick connect DIN connector
Maximum pressure @25 °C	3 bar (43.5 psi)	3 bar (43.5 psi)

5. DESCRIPTION

5.1. GENERAL DESCRIPTION & INTENDED USE

BL100 & BL101 pump controllers are part of Hanna Instruments® pool-line family and feature a single peristaltic dosing pump and a process electrode.

The BL100 accepts HI10053 pH probes. The BL101 accepts HI20083 ORP probes. These probes are manufactured by Hanna Instruments specifically for these controllers.

The probes are easily installed using ½" NPT threads for in-line or flow cell installation.

The electrodes have a matching pin that prevents ground loop effects from causing erratic readings and damage to the system.

Main Features

- Built-in peristaltic pump with On/Off or Proportional control
- Manual control for pump priming
- Overfeed protection using overtime safety timer
- Resumes dosing on restart in case of power failure
- Easy to read LCD display with intuitive, color-coded backlight
- Level input to stop control without reagents
- Probe detection and recognition
- User selectable languages (English, Spanish, French, Portuguese, Dutch, German)
- Specially designed to detect a broken pH electrode, based on a shifted ISO potential value
- Easy to navigate menu to program and adjust settings
- Wall-mounted design
- IP65-rated casing

Main Benefits

- Reduced installation time and costs
- Accessible and easy to maintain feeding system

The **BL100** measures the pH of a pool and offers automatic pH level control by adjusting the chemical dosing.

The **BL101** measures the chlorine level of a pool and offers automatic ORP level control by adjusting the chemical dosing.

BL100 and **BL101** can work together, stabilizing first the pH value and later the ORP value in the pool.

Each controller type works with one parameter only. If a wrong probe is used (e.g. **HI20083** for **BL100**), the controller signals the error by displaying "WRONG PROBE" message.

The chlorine level is measured based on the ORP or REDOX principle. An increase in the ORP value correlates with an increase in the free-chlorine level.

pH and disinfectant testing are made together for efficient disinfection and control. The efficacy of sanitizers, such as chlorine, is dependent on a controlled pH value. The ORP value is the most consistent indicator of the sanitizing effectiveness of the pool. Typically, 650-750 mV at 7.2 pH indicates proper water treatment.

Based on individual requirements, users can define the ideal set point for pH (e.g. 7.2 pH for **BL100**) and ORP (e.g. 700 mV for **BL101**).

The **BL100** model doses acid if water pH is above the assigned pH set point; and the **BL101** model doses hypochlorite if the ORP value is lower than the ORP set point.

The pump controller is an automatic system but it's advisable that users check the controller and verify pH and free-chlorine levels (in mg/L or ppm) in the pool using a portable colorimeter.

The pump controller should only be used in combination with liquid acid (e.g. sulfuric acid) and liquid chlorine (e.g. sodium hypochlorite).

5.2. FUNCTIONAL & DISPLAY DESCRIPTION

BL100 Front Panel

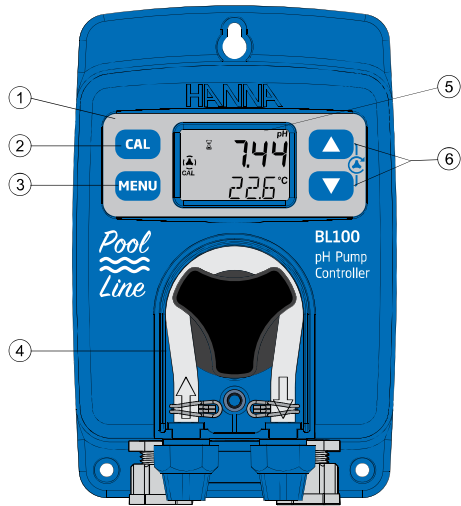

1. Keypad area
2. CAL key – Press calibration key to enter calibration mode.
3. MENU key – Press menu key to enter setup mode and move through the menu.
– A long press of this key is used to exit the menu and return to measurement.
4. Acid (or base) dosing pump
5. LCD display
6. Arrow keys – When in measurement mode, press the two arrow keys together to prime the pump.
– When in menu mode, adjust settings.
– When in menu mode, in Control screen, press the arrow keys together and a 10 seconds pump test will start.

BL100 Liquid Crystal Display (LCD)

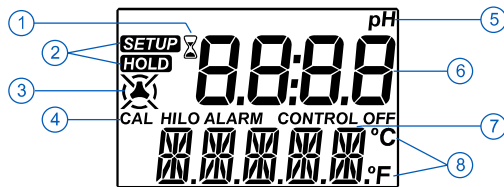

- | | |
|------------------------|--|
| 1. Stability indicator | 5. Measurement unit |
| 2. Mode tags | 6. First LCD line, measurement line |
| 3. Dosing pump icon | 7. Second LCD line, temperature and message area |
| 4. Status indicators | 8. Temperature units |

BL101 Front Panel

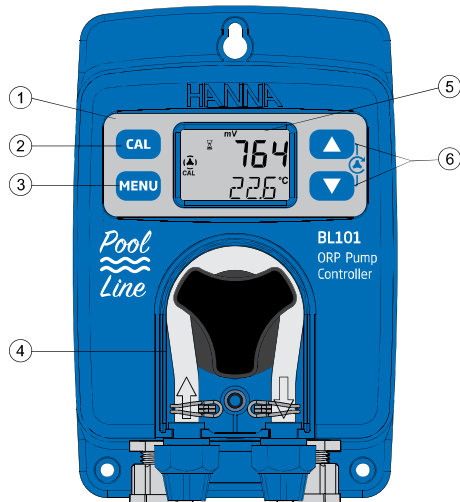

1. Keypad area
2. CAL key — Press calibration key to enter calibration mode.
3. MENU key — Press menu key to enter setup mode and move through the menu.
— A long press of this key is used to exit the menu and return to measurement.
4. Chlorine dosing pump
5. LCD display
6. Arrow keys — When in measurement mode, press the two arrow keys together to prime the pump.
— When in menu mode, adjust settings.
— When in menu mode, in Control screen, press the arrow keys together and a 10 seconds pump test will start.

BL101 Liquid Crystal Display (LCD)

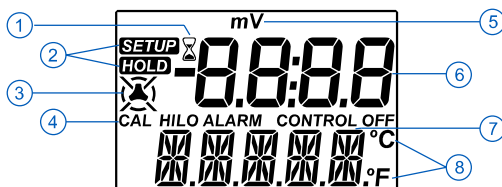

1. Stability indicator
2. Mode tags
3. Dosing pump icon
4. Status indicators
5. Measurement unit
6. First LCD line, measurement line
7. Second LCD line, temperature and message area
8. Temperature units

Rear Panel & Internal View

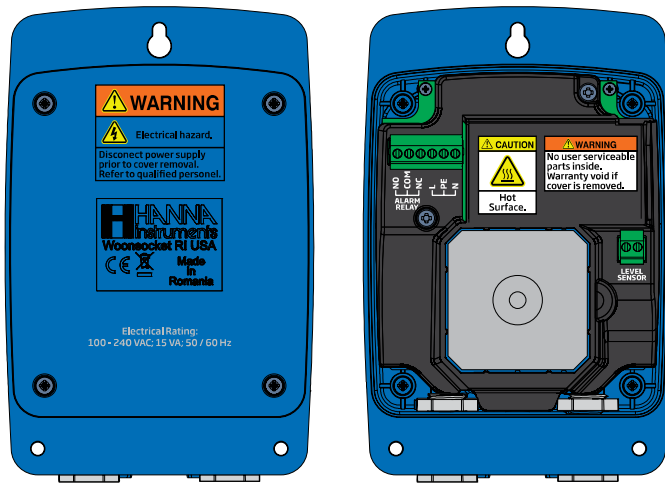

Use a Phillips head screwdriver and remove the four screws, pull back the cover and remove it.

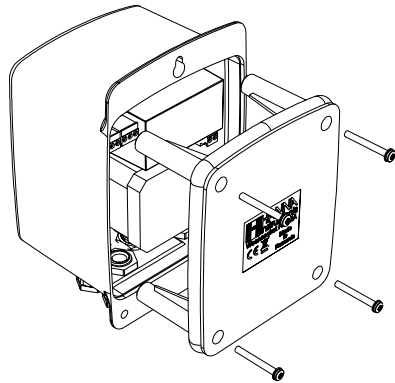

To replace the rear panel, insert the four legs back in place and tighten the four screws that secure the panel to the enclosure.

Alarm Relay, Power & Level Input

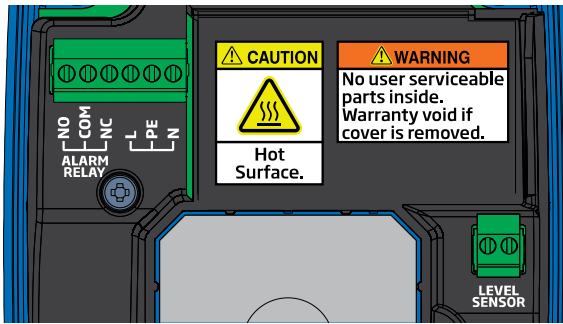

ALARM RELAY OUTPUT SPDT 2.5 A / 230 Vac	NO	Normally Open
	COM	Common
	NC	Normally Closed
	Pump controller not powered or Alarm condition	
	Working condition with no alarm	

POWER INPUT	L	Line – Hot connection
	PE	Protective Earth – Ground connection
	N	Neutral

LEVEL SENSOR (Enabled in Setup)	
------------------------------------	--

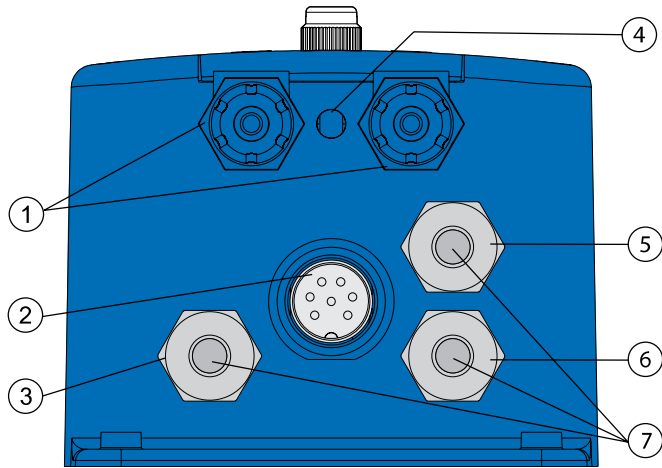

1	Tubing fittings
2	Sensor input
3	Cable gland for level sensor
4	Drainage opening
5	Cable gland for alarm cable
6	Cable gland for power cable
7	Enclosure cap

Cabling safety measures. Qualified personnel should perform wiring only.



- A disconnect switch must be installed to break all current carrying conductors. Turn off power before working on conductors.
- Always disconnect the pump controller from power when making electrical connections.
- Do not run other cables with the power cable through the cable gland.
- Always run all cables through cable glands to maintain IP65 rating.

6. INSTALLATION

General Guidelines

- Select controller location so that it is shielded from direct sunlight, dripping water and excess vibrations.
- Keep flow rate as constant as possible for optimum sensor operation.
- Install cable gland fittings and plugs, to properly seal the pump controller.
- The probes are easily installed using ½" NPT threads for in-line or flow cell installation.
- Ensure all tubing, cables, saddles and fittings are properly connected.

Wiring Guidelines

Running cables through cable glands

- Unscrew the gland nut and remove the cap.
- Thread cable through outer opening of proper gland nut, through the seal, and into case.
- After connecting to terminal, reinsert seal and tighten nut on the threaded gland.

Connecting cables to the internal terminals

- Using a screwdriver, connect the cable leads to the appropriate terminal.
- Following the printed lead markings (L, PE, N for power supply; NO, COM, NC for relay; level sensor if required) ensure the leads are wired to the correct position.

Installation Steps

1. Check the tank level.
2. Calibrate the probe before use in the system.
3. Mount the probe into saddle or into a flow cell.
4. Measure and cut required length to connect tubing between filter in chemical tank and pump's inlet (aspiration tubing).*
5. Measure and cut required length to connect tubing between pump's outlet and injector (injection tubing).
6. Check the level sensor's functionality (if used).

* Suggested maximum length for vertical installations is 5 m (16.4 ft).

Installation Schemes

We are proposing a few typical installation schemes: in-line and flow cell.

In-Line Installation, Overview & Parts Table

A detailed representation of an in-line installation with relevant components is found below.

The maximum pressure entering the flow cell system is 3 atm (44 psi).

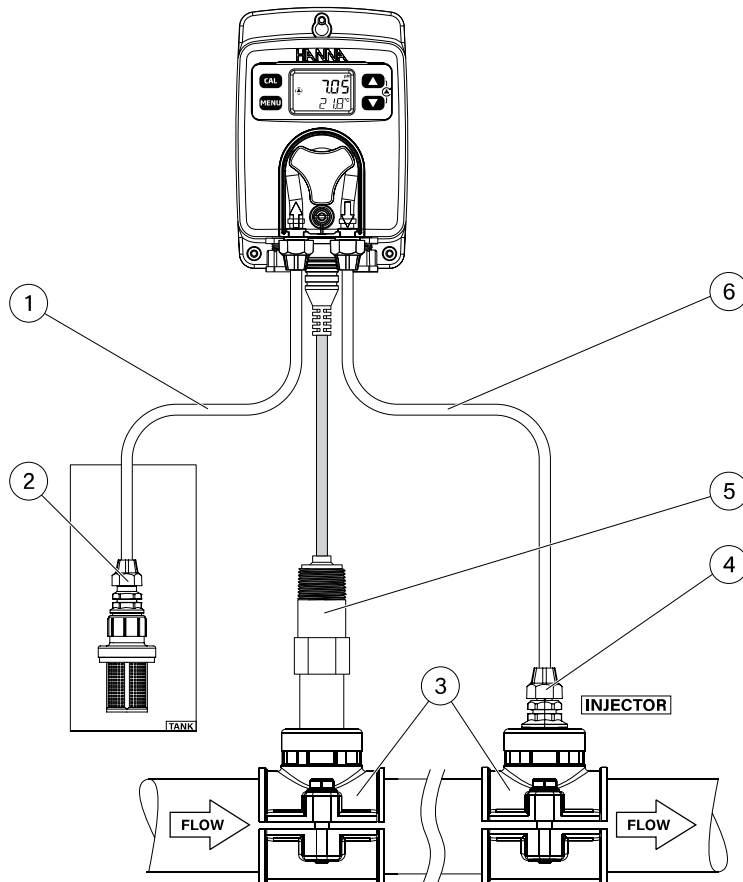

Note: Injectors prevent back flow into reagent tank.

1	Aspiration tubing Ø 6.0 mm (¼")
2	Aspiration filter
3	Saddle for Ø 50 (2") mm pipe, using ½" NPT thread
4	Injector, ½" NPT thread
5	Electrode
6	Injection tubing Ø 6.0 mm (¼")

Flow Cell Installation, Overview & Parts Table

Below is an illustrated reference of a generic flow-cell installation scheme with the relevant components. The maximum pressure entering the flow cell system (P1) is 3 atm (44 psi) and decreases when it exits the flow-cell (P2). The maximum pressure for the pump (P3) is 1 atm (14 psi).

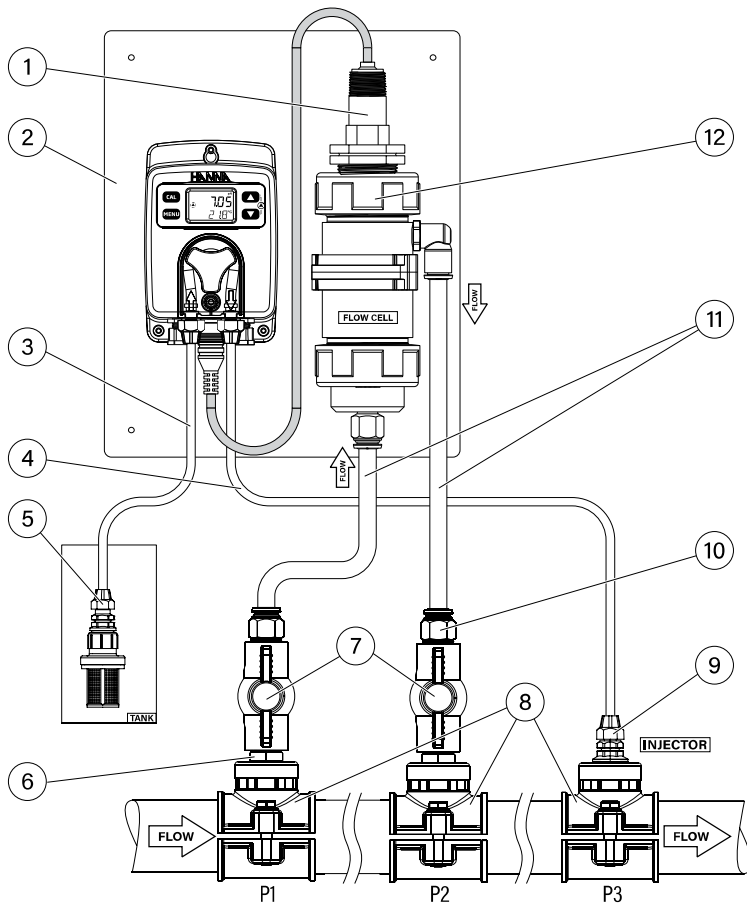

1	Electrode	8	Saddle for Ø 50 mm (2") pipe, using ½" NPT thread
2	Mounting panel	9	Injector, ½" NPT thread
3	Aspiration tubing Ø 6.0 mm (¼")	10	Adapter for tubing ½" to Ø 12 mm
4	Injection tubing Ø 6.0 mm (¼")	11	Rigid PE tubing Ø 12 mm
5	Aspiration filter	12	Flow cell and adapter
6	Nipple, ½" × ½"		
7	Valve to control flow-cell flow		

Mounting Recommendations for Saddle

- Select required drill size. See table for dimension details.

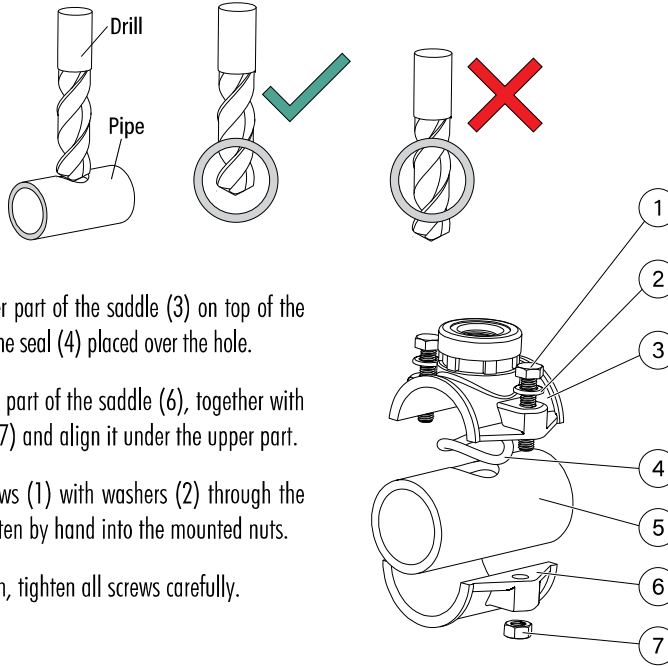

- Place the upper part of the saddle (3) on top of the pipe (5) with the seal (4) placed over the hole.
- Take the lower part of the saddle (6), together with inserted nuts (7) and align it under the upper part.
- Insert the screws (1) with washers (2) through the holes and tighten by hand into the mounted nuts.
- Using a wrench, tighten all screws carefully.

Saddle for probe & injector	Thread size	Drill size
Ø 50 mm pipe	½" NPT thread	20 mm - 25.4 mm
Ø 63 mm pipe	½" NPT thread	20 mm - 25.4 mm
Ø 75 mm pipe	½" NPT thread	20 mm - 25.4 mm

Connecting the Probe to the Pump Controller (In-line Configuration)

The probe should be connected to the controller and calibrated before installation.

To avoid twisting the cable, unplug probe from socket temporarily while installing in saddle.

Insert the probe and screw it carefully into the saddle, taking care not to damage the O-ring. Tighten the probe enough to ensure a tight seal.

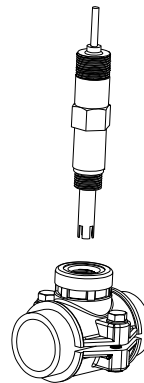

Installing Aspiration Filter

The aspiration filter is used in the reagent tank to filter and prevent debris from entering the tubing.

- Cut required length of aspiration tubing (flexible) to reach between peristaltic pump inlet and aspiration filter.
- Place the end of tubing on the filter.
- The compression fitting has to be screwed until secured on the filter.
- Slide the compression fitting from the peristaltic pump inlet onto the tubing.
- Slide the end of tubing over the fitting of the peristaltic pump tubing.
- Slide compression fitting up over tubing.
- Tighten the fitting.

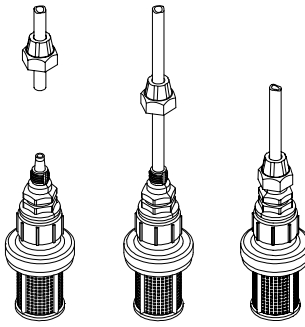

Installing Injector

- Cut the required length of injection tubing to reach between injector saddle and outlet of peristaltic pump.
- Place the compression fitting nut on the tubing.
- Place the end of tubing on the injector.
- The compression fitting has to be screwed until secured on the injector.
- Screw the injector in the saddle.
- Slide compression fitting from pump tubing onto tubing.
- Slide the end of tubing over fitting of pump tubing.
- Slide compression fitting over tubing.
- Secure and tighten the fitting.

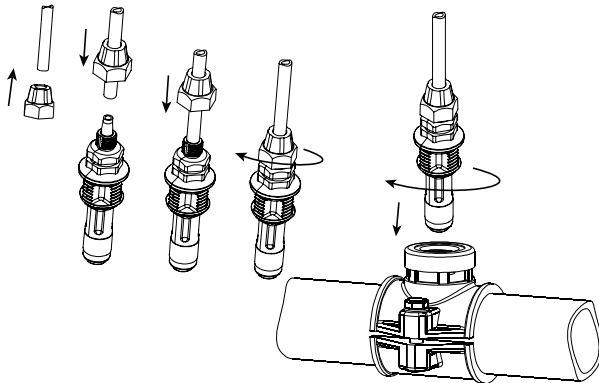

Flow Cell Installation

In a flow cell configuration, the water flows from the inlet valve to the flow cell and returns in the line via the outlet valve.

To prepare the inlet and outlet valve assemblies, as illustrated in the drawing:

- To mount the saddle for flow cell inlet and outlet valve, follow mounting recommendations for saddle.
- Sparingly lubricate two O-rings (2) with a thin film of grease and mount them on the nipple (1) on both sides.
- Screw the nipple in the saddle (3).
- Screw the valve (4) into the open end of the nipple mounted into the saddle. Make sure it is tight and the lever is facing forward so that it can be operated.
- Carefully screw the straight tubing fitting (5) into the valve, taking care not to damage the O-ring.
- Insert the tubing (6) in the straight tubing fitting (5).

1	Nipple
2	Saddle
3	O-ring
4	Valve
5	Tubing fitting
6	Tubing

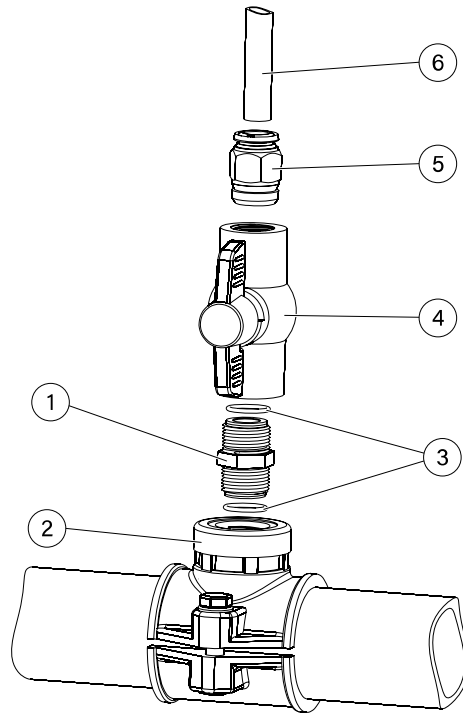

Connecting the Probe to the Pump Controller (Flow Cell Configuration)

- Remove the protective cap and verify the O-ring (2) is in place.
- *Note: The probe should be connected to the controller and calibrated before installation.*
- To avoid twisting the cable, unplug probe from socket temporarily while installing in flow cell.
- Assemble the fixing nut (4) with the flow cell O-ring (5) inside the adapter (3). Tighten the adapter enough to seal in place taking care not to damage the O-ring (5).
- Carefully insert the probe (1) into the flow cell adapter (3), paying attention not to damage the adapter O-ring (2). Tighten the probe enough to seal in place.
- Cut the rigid PE tubing (9) to reach between flow cell inlet (bottom) and the pipe mounted outlet valve. Push the end of the tubing (9) into the tubing fitting (8).
- Repeat the previous step for flow cell outlet pushing the tubing (7) into the elbow tubing fitting (6).

1	Probe
2	Adapter O-ring
3	Adapter body
4	Adapter fixing nut
5	Flow cell O-ring
6	Elbow tubing fitting
7	Outlet rigid PE tubing 12 mm
8	Tubing fitting 12 mm
9	Inlet rigid PE tubing 12 mm

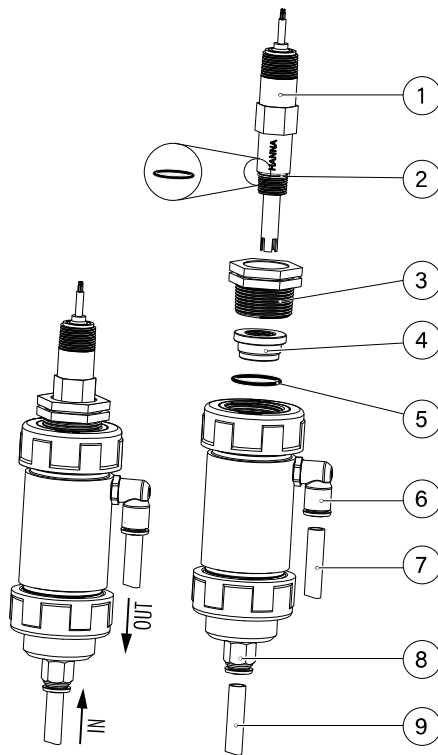

7. SETUP

- Short press MENU key to enter in Setup and to move to next item in menu.
- Long press MENU key to exit.
- Press arrow keys to change the values.
- Short press MENU key to automatically save modified values.

Table below presents an overview of BL100 menu with ranges and factory set defaults.

Parameter (Scrolled message)	Range / Option	Default settings
Control	Auto or oFF	Auto
Control type	on/oFF or Proportional	on/oFF
Control mode	Hi or Lo	Hi
Set point	6.00 to 8.00	7.20
Hysteresis (on/oFF only)	0.1 to 1.00 pH	0.50
Band (Proportional only)	0.1 to 2.00 pH	1.0
Start up delay (seconds)	0 to 600	60
Overtime alarm (minutes)	oFF, 0 to 180	30
Flow rate (Liter/hour)	0.5 to 3.5	1.0
Flow rate (Gallon/hour)	0.13 to 0.92	0.26
Level alarm	diS or En	diS
High alarm	diS or En	En
High alarm value (pH)	0 to 14.00 pH*	8.00 pH
Low alarm	diS or En	diS
Low alarm value (pH)	0 to 13.90 pH*	6.00 pH
Temperature unit	°C or °F	°C
Flow rate unit	L.H or GAL.H	L.H
Language	En (English), ES (Spanish), Fr (French), Pt (Portuguese), nL (Dutch), dE (German)	En (English)

*Available range changes, based upon other settings.

High alarm must be set higher than low alarm. If low alarm was set 7 pH, then high alarm range is 7.1 to 14 pH.

Table below presents an overview of BL101 menu with ranges and factory set defaults.

Parameter (Scrolled message)	Range / Option	Default Settings
Control	Auto or oFF	Auto
Control type	on/oFF or Proportional	on/oFF
Control mode	Hi or Lo	Lo
Set point	200 to 900 mV	700 mV
Hysteresis (on/oFF only)	10 to 100 mV	50 mV
Band (Proportional only)	10 to 200 mV	100 mV
Start up delay (seconds)	0 to 600	60
Overtime alarm (minutes)	oFF, 0 to 180	30
Flow rate (Liter/hour)	0.5 to 3.5	1.0
Flow rate (Gallon/hour)	0.13 to 0.92	0.26
Level alarm	diS or En	diS
High alarm	diS or En	diS
High alarm value (mV)	-1990 to 2000 mV*	900 mV
Low alarm	diS or En	En
Low alarm value (mV)	-2000 to 1990 mV*	200 mV
Temperature unit	°C or °F	°C
Flow rate unit	L.H or GAL.H	L.H
Language	En (English), ES (Spanish), Fr (French), Pt (Portuguese), nL (Dutch), dE (German)	En (English)

*Available range changes, based upon other settings.

High alarm must be set higher than low alarm. If low alarm was set 1000 mV, then high alarm range is 1010 to 2000 mV.

Control

Option: Auto or Off (oFF) to enable or disable the control

With disabled option oFF, the control is off.

Press one of the arrow keys for the controller settings to change from Auto to oFF and vice versa.

To run a ten-seconds pump test, long press the arrow keys together until the pump starts to run.

“CONTROL” message is scrolled on the bottom of the LCD screen.



Control Type

Option: On Off (on/oFF) or Proportional (ProP)

Press the arrow keys to switch between on/off and proportional options.

“CONTROL TYPE” message is scrolled on the bottom of the LCD screen.

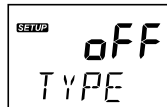
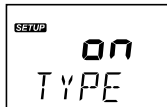

Note: To enter Control Type screen, pump control mode must be set as Auto.

Control Mode

Option: Low (Lo) mode or High (Hi) mode

Press the arrow keys to switch between the options.

“CONTROL MODE” message is scrolled on the bottom of the LCD screen.



Note: To enter Control Mode screen, pump control mode must be set as Auto.

Set point

General: a set point is a threshold value that will trigger control if the measurement value crosses it.

With a Hi control mode, the measurement approaches the set point from a lower measurement value. With a Lo control mode, the measurement approaches the set point from a higher measurement value than the set point.

Option: user selectable

Press the arrow keys to assign the set point value.

“SET POINT” message is scrolled on the bottom of the LCD screen.



Note: To enter Set point screen, pump control mode must be set as Auto.

Hysteresis / Proportional Band

Hysteresis (On/Off Control only)

With On/Off control a relay is activated to cause chemical dosing when the measurement crosses the threshold value.

On/Off control action turns the dosing on or off based on a previously assigned set point. The pump status (running/not running) changes depending on pH/ORP changes. To prevent oscillation, a pH/ORP band, called hysteresis, is created between the on and off operations.

The pump starts dosing when the measurement crosses the set point value. The pump stops dosing when the measurement crosses the set point value \pm hysteresis band.

In order to set the hysteresis value, automatic control must be enabled, with On/Off control type On.

Proportion band (Proportional Control only)

The proportional band is a control variable and is defined as the amount of change in input, required to cause the control output to go through 100% of operating range.

In order to set the proportional band value, automatic control must be enabled, with Proportional control type on. The pump is continuously on at the set point value with added band.

Option: user selectable

Press the arrow keys to set the value.

“HYSTERESIS” or “PROPORTIONAL BAND” message is scrolled on the bottom of the LCD screen.



Note: To enter Hysteresis / Band screen, pump control mode must be set as Auto.

Startup Delay (Automatic Control Only)

Option: user selectable (0 to 600s)

Startup delay represents the delay to start dosing at power-on.

Press the arrow keys to change the time values.

“STARTUP DELAY SEC” message is scrolled on the bottom of the LCD screen.

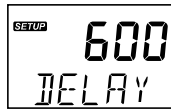

Note: To enter Startup Delay screen, pump control mode must be set as Auto.

Overtime Alarm

Option: user selectable (off, 1 to 180 minutes)

Press the arrow keys to change the time values. Overtime alarm range is from 1 to 180 minutes.

To disable the alarm, select Off.

“OVERTIME ALARM MIN” message is scrolled on the bottom of the LCD screen.



Note: To enter Overtime alarm screen, pump control mode must be set as Auto.

Flow Rate

Option: selectable (0.5 to 3.5 L/hour, 0.13 to 0.92 G/hour)

Press the arrow keys to change the values.

When in On/Off automatic control mode, the displayed value represents the actual flow rate.

When in Proportional automatic control mode, the displayed value represents a 100% flow rate.

“FLOW RATE L/H” or “FLOW RATE G/H” message is scrolled on the bottom of the LCD screen.

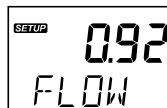
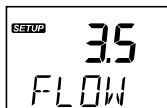

Level Alarm

Option: Enabled (En) or disabled (diS)

Press the arrow keys to switch between the options.

"LEVEL ALARM" message is scrolled on the bottom of the LCD screen.

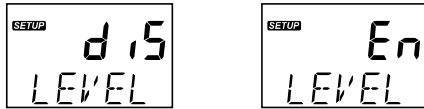

Note: Option can only be used with properly wired level sensor.

High Alarm

Option: Enabled (En) or disabled (diS)

Press the arrow keys to switch between the options.

"HIGH ALARM" message is scrolled on the bottom of the LCD screen.

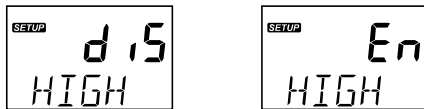

High Alarm Value

Option: user selectable

The range is influenced by the low-alarm value set (e.g. if low-alarm value is set as 5 pH, high-alarm value can be set from 5.10 pH and incremented up to 14.00 pH).

"HIGH ALARM VALUE" message is scrolled on the bottom of the LCD screen.



Note: The user can set the high-alarm value with high-alarm option enabled only.

Low Alarm

Option: Enabled (En) or disabled (diS)

Press the arrow keys to switch between the options.

"LOW ALARM" message is scrolled on the bottom of the LCD screen.



Low Alarm Value

Option: user selectable

The range is influenced by the high-alarm value set (e.g. if high-alarm value is set as 8 pH, low-alarm value can be set from 0.00 pH and incremented up to 7.90 pH).

"LOW ALARM VALUE" message is scrolled on the bottom of the LCD screen.



Note: The user can set the low-alarm value with low-alarm option enabled only.

Temperature Unit

Option: user selectable: °C or °F

Press the arrow keys to change the unit.

"TEMPERATURE UNIT" message is scrolled on the bottom of the LCD screen.

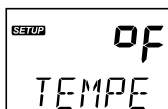
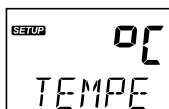

Flow Rate Measurement Unit

Option: Liter/hour (L.H) or Gallon/hour (GAL.H)

Press the arrow keys to switch between the options.

"FLOW RATE UNIT" message is scrolled on the bottom of the LCD screen.

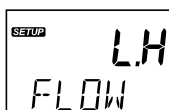

Languages

Option: Select from: En (English), ES (Spanish), Fr (French), Pt (Portuguese), nL (Dutch), dE (German)

Press the arrow keys to change the language.

"LANGUAGE" message is scrolled on the bottom of the LCD screen.



Note: "LANGUAGE" message, scrolled on the second line, is translated into the selected language.

8. PRIMING THE PUMP

Pump control can be enabled (automatic control) or disabled (off; manual control). See SETUP section for further details on how to enable or disable pump control. LCD backlight color indicates the pump control status:

- green - automatic control or in View menu mode
- light green - for manual control or in Edit menu mode

On the LCD screen, the pump status is displayed as below:

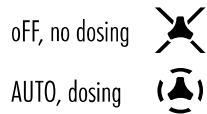

Startup Delay (Automatic Control Only)

When Startup Delay option is enabled, the meter is in Control Off mode for the set time; and the LCD backlight color is light green. The delay countdown will start upon powering the controller. At the end of the timing the LCD backlight turns green and the control mode is automatic (Auto).

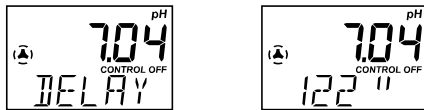

8.1. AUTOMATIC CONTROL TYPES

There are two automatic control types: On/Off (constant) control and proportional control.

On/Off Control

With On/Off control type for pH enabled in SETUP, the algorithm uses only "set point" and "hysteresis", both with user-selectable values. See SETUP section for further details.

High Control mode: When the process pH drifts upward and it reaches a high set point, this triggers the reagent pump to turn on and add an acid to decrease the pH. The pump will remain on until the pH has decreased to the set point value minus the hysteresis value. Then the pump will shut off.

Low Control mode: Conversely, with Low control mode, the process pH drifts down until it reaches a low set point. This triggers the pump to turn on and add a base to increase the pH. The pump will remain on until the pH has increased to the set point value plus the hysteresis value. Then the pump will shut off.

The typical pool application uses a high control point with the addition of an acid.

The BL101 operates in a similar manner with ORP as measurement and chlorine for dosing.

The typical pool application uses a low control point and the addition of chlorine solution to increase the ORP value.

On/Off Control

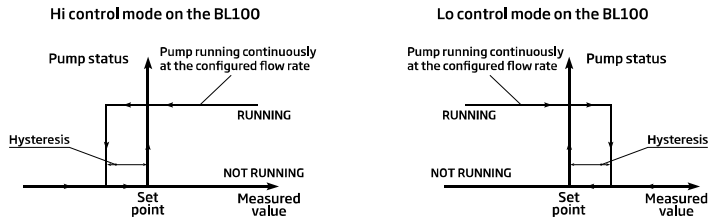

Proportional Control

With Proportional control enabled in SETUP, the dosing time depends on the difference between pH (or ORP) value and assigned setpoint.

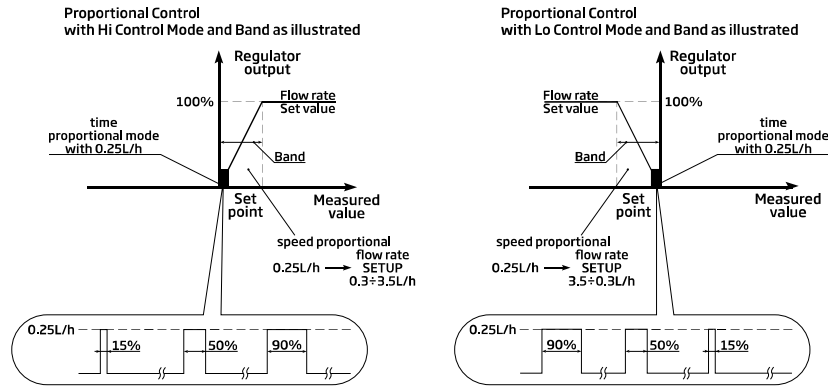

An overview of pH proportional control is presented in the graph below.

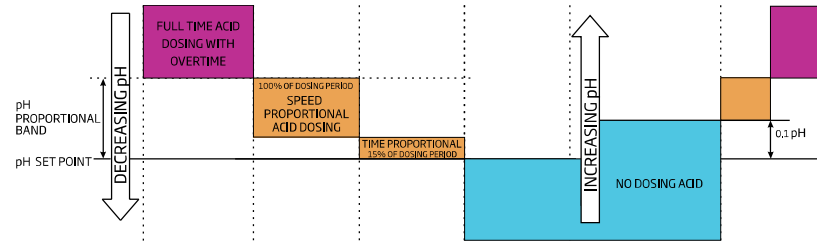

The same principle applies to ORP control.

8.2. PRIMING THE PUMP

- From measurement mode, long press the arrow keys together to manually activate the pump.
- To exit, release the two keys.
- When there are no errors or active alarm the LCD backlight is light green.





9. EVENTS MANAGEMENT

9.1. ALARMS

Alarms can be independently enabled or disabled in SETUP.



Any event that activates the alarm turns automatic control Off, the alarm relay is deactivated and the LCD backlight is blinking red.

The table below illustrates the conditions that will activate the alarm and deactivate the control pump.





Alarm	Description	Alarm condition	Solution
Overtime alarm	Pump remains on continuously for the time set in menu Overtime Alarm setting		Control can be switched off. Pump is activated in Manual mode.
Hold level alarm	Low-level sensor active		Refill chemical reagent container.
Low alarm	Measured pH / ORP is lower than the Low Alarm threshold value, for more than 5 seconds		Increase pH / chlorine content of process to acceptable values.
High alarm	Measured pH / ORP is higher than set threshold alarm High pH, for more than 5 seconds		Decrease process pH / chlorine content to acceptable values.

9.2. WARNINGS

Two types of warnings can be independently enabled or disabled in SETUP. If any of the warnings is active, the LCD backlight turns light green.

Warnings	Description	Screenshot for warning solution	Solution
Startup delay	Start up delay is active	 	Press the up / down arrows at same time to restart pump. Access pH, ORP, reagent levels to determine why pH or chlorine level is off.
Control Off	Control is switched Off		Set Control setting to Auto

9.3. SUMMARY OF GENERAL BEHAVIOR

Behavior	Control	Backlight	Alarm Output Relay
Control - auto	auto	green 	off
Warning active	off	light green 	off
Error active	off	red 	on
Alarm active	off	red (blinking) 	on

10. CALIBRATION

10.1. pH CALIBRATION (BL100 ONLY)

The BL100 provides a digital calibration at the push of a button. Calibrate the probe frequently for improved accuracy. Also:

- before in-line or flow cell installation
- whenever the probe is replaced
- after periodic maintenance

Always use fresh calibration buffers and perform electrode maintenance prior to calibration (see ELECTRODE CONDITIONING & MAINTENANCE section) .

Preparation

Pour the buffer solution into clean beakers. If possible, use plastic beakers to minimize any EMC interferences. For accurate calibration and to minimize cross-contamination, use two beakers, one for rinsing the probe and one for calibration.

User Calibration

One- or two-point calibration can be performed using one of the three standard buffer solutions: 4.01, 7.01 or 10.01 pH.

When a two-point calibration is required, use 7.01 pH buffer as first calibration point.

Procedure

- Press CAL key to enter calibration mode.
- Place the electrode in chosen pH buffer solution.
- Press CAL key to save calibration point and return to measurement screen.
- Long press MENU key to exit without saving.

One-Point Calibration

- Press CAL key to enter calibration mode. "pH 7.01 USE" message is displayed as calibration point.
- Place the electrode in 4.01, 7.01 or 10.01 pH buffer. The controller automatically recognizes the buffer value.
- When the buffer is recognized, "RECOGNIZED" is scrolled at the bottom of the LCD display. "WAIT" is displayed until the reading is stable and the calibration is accepted.



- If the buffer is not recognized (either because the pH electrode has not been placed in solution or the reading is outside accepted range), "---- WRONG" message is displayed along with CAL tag blinking.

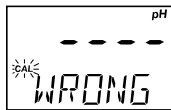

- After pH 4.01 or 10.01 buffer is accepted, the "SAVE" message is displayed and the controller returns to measurement mode.

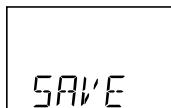

- The "CAL" tag is displayed automatically in measurement mode after a calibration has been performed.

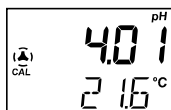

Note: To perform one-point calibration using 7.01 buffer, press CAL key after the buffer is saved.

Two-Point Calibration

- Follow One-Point Calibration section for one-point calibration using pH 7.01. "RECOGNIZED" message is scrolled at the bottom of the LCD until the buffer is recognized.
- After pH 7.01 has been accepted, the "pH 4.01 USE" message is displayed.
- Place the electrode in the second calibration buffer (pH 4.01 or 10.01); it will be automatically recognized. After the second buffer has been accepted, the "SAVE" message is displayed for 1 second and the controller returns to measurement mode.

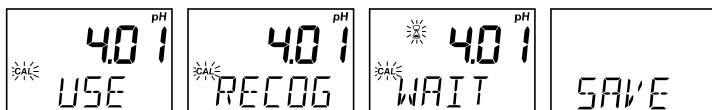

OR



- The "CAL" tag will be displayed in measurement mode after the calibration.



- If the buffer is not recognized, "---- WRONG" message is displayed. It is recommended to change the solution and / or clean the electrode.

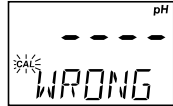

- Press CAL key to exit calibration.

Note: If high accuracy is required, a two-point calibration is recommended.

10.2. PROCESS pH & ORP CALIBRATION

Process pH Calibration

Prior to performing a process calibration, determine the value using a reference meter. Make a note of the value.

Note: To enter process calibration, the user must have the controller and probe calibrated previously on the meter. The "CAL" tag must be on.

pH process calibration is a single point calibration performed while the probe remains installed in the process. The value can be set ± 0.50 pH around measured pH.

- Press CAL key to enter calibration mode. When the first buffer value is displayed, press one of the arrow keys to enter process calibration.



- Press the arrow keys again to adjust the process calibration value to what was determined with the hand held measurement. "PROCESS" message is scrolled on the bottom of the LCD screen.

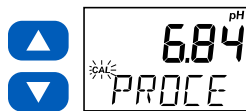

- Press CAL key to confirm the value (the "SAVE" message appears for a few seconds).
- Press MENU key to exit without saving and return to measurement mode (the "ESC" message is displayed for a few seconds).

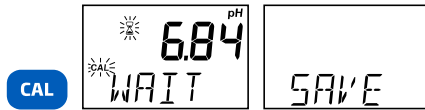

Process ORP Calibration (BL101 only)

ORP calibration is a single point process calibration. The value can be set ± 50 mV around measured ORP.

The probe may be calibrated in an ORP standard prior to installation or it may also be calibrated while installed in the process by adjusting the value to that of a calibrated portable meter.

- Place probe tip into beaker of standard.
- Wait for it to equilibrate.
- Follow the ORP process directions below to calibrate the probe and controller.
- Wash with purified water before handling and installing into pool control piping.
- Dispose of standard safely.
- Press CAL key to enter calibration mode.



- Press the arrow keys to adjust the process calibration value to the value determined with a hand held meter and probe. "PROCESS" message is scrolled on the bottom of the LCD screen.

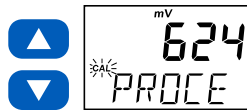

- Press CAL key to confirm the value (the "SAVE" message is displayed for a few seconds).
- Press MENU key to exit without saving and return to measurement mode (the "ESC" message appears for a few seconds).

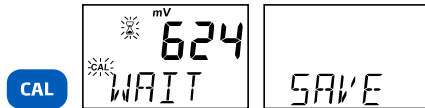

10.3. CLEAR CALIBRATION

- Press CAL key and the controller enters calibration mode.

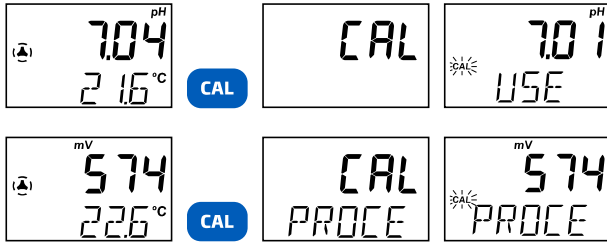

- Long press MENU key and the "CLEAR" message is displayed.
- No "CAL" tag in measurement mode, indicates the probe is no longer calibrated.

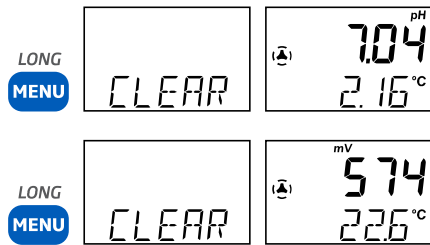

11. MEASUREMENT

- Power the controller. All LCD segments will be displayed for a few seconds. After initialization has been completed, the controller displays the measurement screen.
- Plug the probe into the dedicated socket. Use the key to install properly.
- The pH / ORP electrode is automatically recognized. If the wrong probe is used, the meter will indicate an error.
- After setting up the controller menu, probe and all required accessories, the controller is ready for measurement.
- From measurement mode, press both arrow keys simultaneously to prime the pump and to verify the flow cell fills correctly (if used).
- If power is lost, then restored, the controller keeps the last used settings and calibration.
- If control mode is enabled (Auto), the pump tag will be displayed. If control is disabled (oFF), the pump tag will be crossed out.

BL100, control enabled



BL101, control disabled

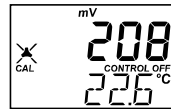

First LCD line displays measured pH / ORP value, the second LCD line displays the temperature. If a calibration was performed, the screen displays the CAL tag.

Measurements are updated every second and conditions are updated automatically. The pump starts or stops depending on configured settings (control mode and type, set point, hysteresis or proportional band, start-up delay timer, overtime time alarms).

12. ERROR MESSAGES

The pump controller shows error messages when erroneous conditions appear and when measured values are outside the expected range.

The information below provides an explanation of the errors, and recommended action to be taken. Error messages are displayed with red LED backlight.

		Probe is not connected. Connect the probe.
		Wrong probe is connected. Unplug the controller and connect the correct probe.
		Broken temperature sensor. Replace the probe.
		Temperature is out of range (BL100).
		Measured value is out of range. pH (BL100) or ORP (BL101).
		Stepper motor error: over temperature or overcurrent is detected. When the error has ceased, the stepper motor resumes normal function.

13. MAINTENANCE

13.1. ELECTRODE CONDITIONING & MAINTENANCE

Preparation

- Remove the electrode protective cap. Do not be alarmed if any salt deposits are present, this is normal. Rinse the probe with water.
- Shake the electrode down as you would do with a clinical thermometer to eliminate any air bubbles inside the glass bulb (pH electrode only).
- If the bulb and/or junction are dry, soak the electrode in [HI70300](#) storage solution for a minimum of 30 minutes. Rinse with water.
- Calibrate before using.
- When the electrode is not in use, add a few drops of [HI70300](#) storage solution to the protective cap and replace the cap. To ensure a quick response, the glass bulb (pH electrode) and the junction should be kept moist and not allowed to dry out. This can be achieved by installing the probe in such a way that it is constantly in the filled flow cell or the pipe filled with the sample.

Note: Never store the electrode in distilled or deionized water.

13.2. PUMP TUBING REPLACEMENT

Note: While replacing tubing, wear protective gloves and eye protection at all times.

1. Power off the controller.

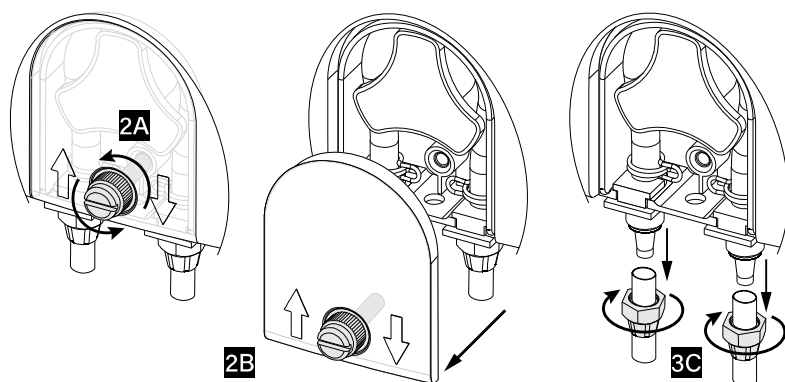

2. Remove the plastic screw securing the transparent cover (2A) and the cover (2B).
3. Disconnect the tubing from the pump (3C).

- Starting from the left side of the pump, grab the peristaltic pump tubing (4A) and rotate the pump rotor manually to the right (4B), until the tubing is removed (4C).
- Grease the new peristaltic pump tubing with silicone oil supplied in the peristaltic pump tubing kit (BL100-300).

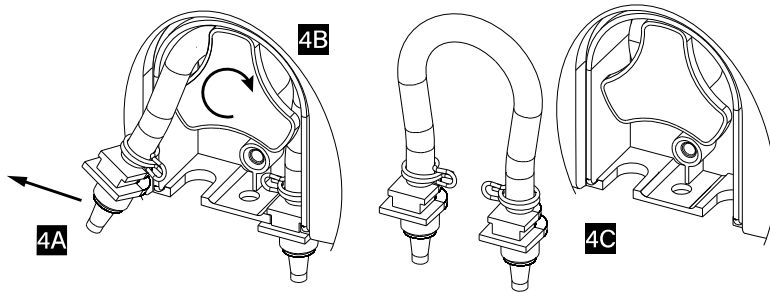

- Place the greased new peristaltic tube on the left side of the pump (6A) and rotate the pump rotor manually to the right (6B) until the tubing is on the pump. Fix the plastic holders on both sides (6C).

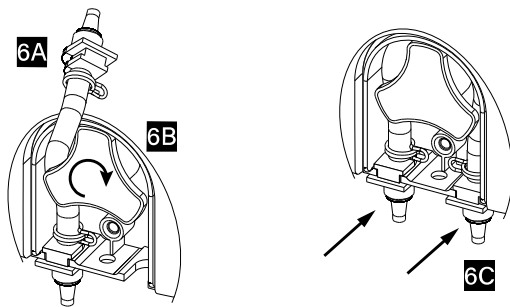

- Reattach the transparent plastic cover (7A) and secure it in place with the plastic screw (7B).
- Reattach the tubing to the pump (8C).

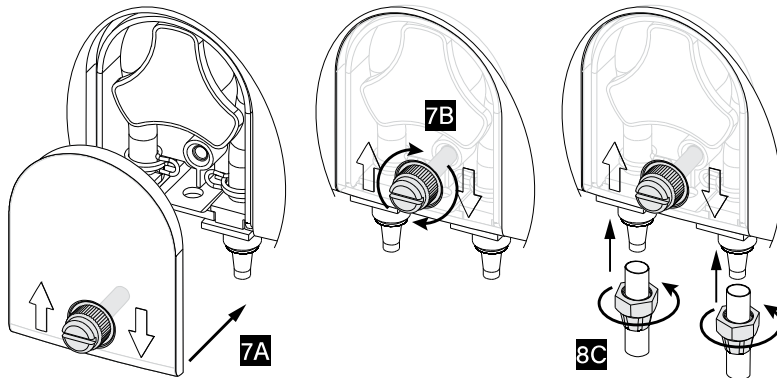

14. ACCESSORIES

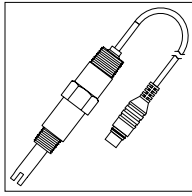

HI10053 pH/temp. probe with 2 m cable, DIN Quick connect

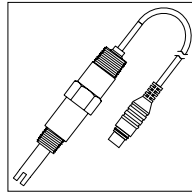

HI20083 ORP/temp. probe with 2 m cable, DIN Quick connect

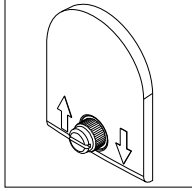

BL100-302 Pump cover with screw

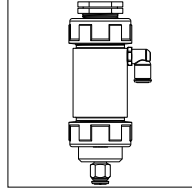

BL120-410 Flow cell for BL100/BL101

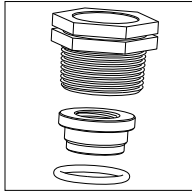

BL100-400 Probe adapter kit (contains adapter, fixing nut, O-ring)

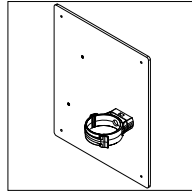

BL100-421 Flow cell panel

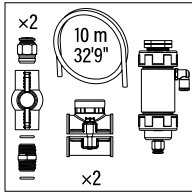

BL120-450 Flow cell kit for Ø 50 mm pipe

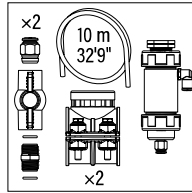

BL120-463 Flow cell kit for Ø 63 mm

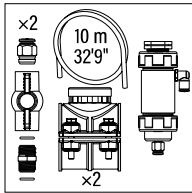

BL120-475 Flow cell kit for Ø 75 mm pipe

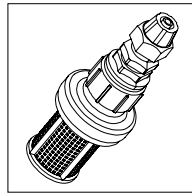

BL120-200 Controller aspiration filter

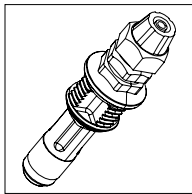

BL120-201 Controller injector, 1/2" NPT thread

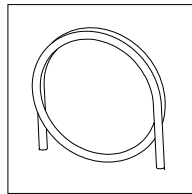

BL120-202 Aspiration and injection tubing, 10 m

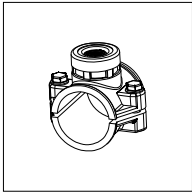

BL120-250
Injector saddle for
Ø 50 mm pipe,
½" NPT thread

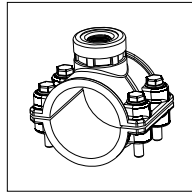

BL120-263
Injector saddle for
Ø 63 mm pipe,
½" NPT thread

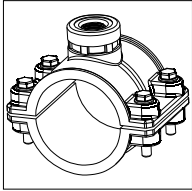

BL120-275
Injector saddle for
Ø 75 mm pipe,
½" NPT thread

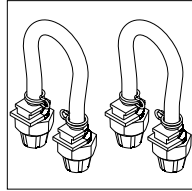

BL100-300
Peristaltic pump
tubing kit (2 pcs.)

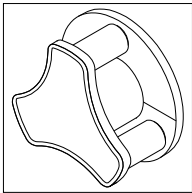

BL120-301
Peristaltic pump rotor

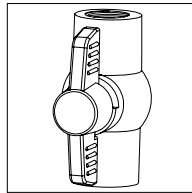

BL120-401
Flow cell valve

Other Accessories

HI70004P	pH 4.01 buffer sachet, 20 mL (25 pcs.)
HI70007P	pH 7.01 buffer sachet, 20 mL (25 pcs.)
HI70010P	pH 10.01 buffer sachet, 20 mL (25 pcs.)
HI70022P	ORP test solution, 470 mV @ 25 °C, 20 mL (25 pcs.)
HI7004L	pH 4.01 buffer solution, 500 mL
HI7007L	pH 7.01 buffer solution, 500 mL
HI7010L	pH 10.01 buffer solution, 500 mL
HI7021L	ORP test solution, 240 mV @ 25 °C, 500 mL
HI7022L	ORP test solution, 470 mV @ 25 °C, 500 mL
HI70300L	Storage solution, 500 mL
HI7091L	Reducing pretreatment solution
HI7092L	Oxidizing pretreatment solution, 500 mL
HI7061L	General cleaning solution, 500 mL
HI740036P	Plastic beaker set, 100 mL (10 pcs.)

CERTIFICATION

All Hanna[®] instruments conform to the **CE European Directives**.



Disposal of Electrical & Electronic Equipment. The product should not be treated as household waste. Instead hand it over to the appropriate collection point for the recycling of electrical and electronic equipment which will conserve natural resources. Ensuring proper product disposal prevents potential negative consequences for the environment and human health. For more information, contact your city, your local household waste disposal service, or the place of purchase.

RECOMMENDATIONS FOR USERS

Before using this product, make sure it is entirely suitable for your specific application and for the environment in which it is used. Any variation introduced by the user to the supplied equipment may degrade the controller's performance. For yours and the controller's safety do not use or store the controller in hazardous environments.

WARRANTY

The **BL100 & BL101** are warranted for two years (probes for six months) against defects in workmanship and materials when used for its intended purpose and maintained according to instructions. This warranty is limited to repair or replacement free of charge. Damage due to accidents, misuse, tampering or lack of prescribed maintenance is not covered.

If service is required, contact your local Hanna Instruments[®] Office. If under warranty, report the model number, date of purchase, serial number (engraved on the bottom of the meter) and the nature of the problem. If the repair is not covered by the warranty, you will be notified of the charges incurred. If the instrument is to be returned to Hanna Instruments, first obtain a Returned Goods Authorization (RGA) number from the Technical Service department and then send it with shipping costs prepaid. When shipping any instrument, make sure it is properly packed for complete protection.

Hanna Instruments[®] reserves the right to modify the design, construction or appearance of its products without advance notice.

World Headquarters

Hanna Instruments Inc.
Highland Industrial Park
584 Park East Drive
Woonsocket, RI 02895 USA
www.hannainst.com



MANBL10X

Printed in ROMANIA