

DMI SERIES 316 STAINLESS STEEL MULTISTAGE PUMPS

The Davies DMI series are an industrial multistage stainless steel pump capable of handling a wide range of applications, from clean water supply, pressure boosting, hot water circulation and rinsing to those harsh aggressive applications involving chemicals & fertilizers.

Features

- 316 Stainless steel impellers, Diffusers, inlet/outlet chambers
- Long Life Silicon carbide/carbon seal
- Quiet & Low running cost
- Easy service clamp band design



TECHNICAL DETAILS

Typical Applications:

- Water supply
- Pressure boosting
- Water treatment
- Circulation
- Industrial washing and rinsing
- Fertilizer dosing systems

Pump Type

- Horizontal non self-priming multistage centrifugal pump for pumping clean, thin, non-explosive, non-flammable, free of solid particles, sand and fibers.

Motor Type

- Totally enclosed, fan cooled standard PSC type motor
- Rated speed: 2850 RPM - 50Hz
- Single phase voltage range: 220-240V
- Three phase voltage range: 220-240/380-415
- Insulation: Class F
- Protection: IP54
- Single phase versions fitted with manual reset overload
- Three phase version require user supplied overload to be fitted in installation

Operation limitations

- Maximum ambient temperature: +40°C
- Liquid temperature range: 0°C to + 110°C
- Maximum operating pressure: 10bar/145PSI



CONSTRUCTION MATERIALS

ITEM NO.	DESCRIPTION	MATERIAL
1	Pump Casing	316 Stainless steel
2	Suction connector	316 Stainless steel
3	Chamber	316 Stainless steel
4	Impeller	316 Stainless steel
5	Coverplate	316 Stainless steel
6	Shaft	316 Stainless steel
7	Mechanical seal	Silicon carbide/silicon carbide
8	O-Ring	Viton
9	Base plate	Steel

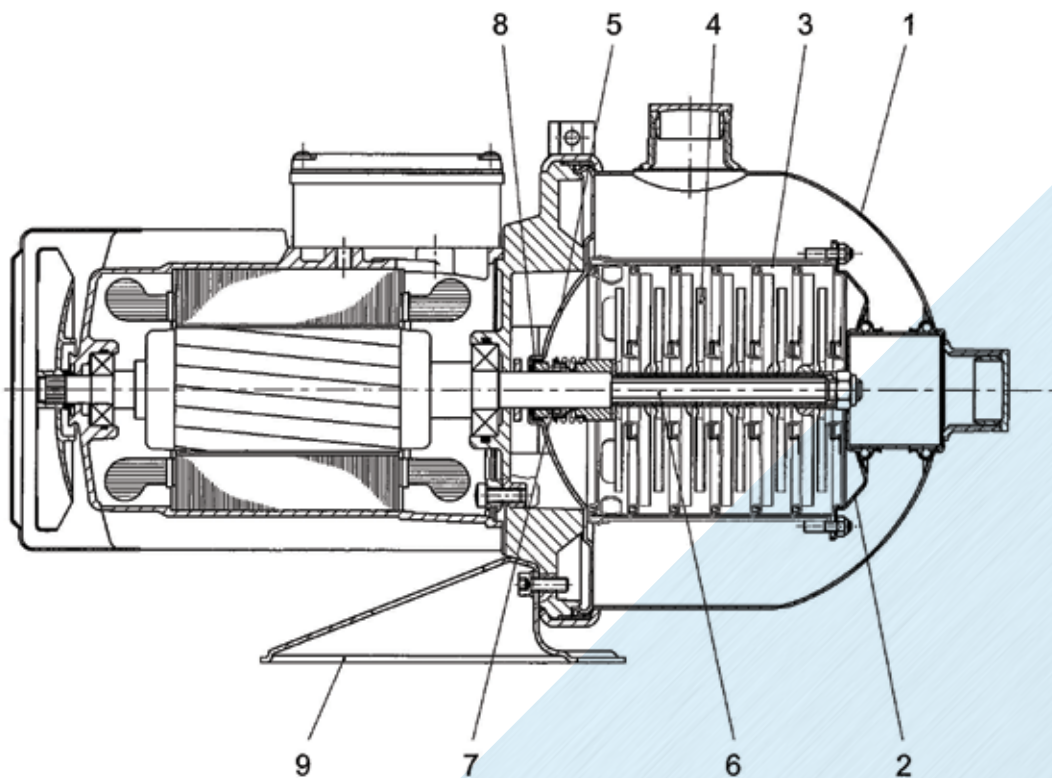

TECHNICAL DATA

DAVIES DMI 2 SERIES						
Model	Hp	Kw (P2)	Kw (P1)	Volts	Phase	Amps
DMI 2-30	0.48	0.35	0.54	230	1	2.4
DMI 2-40	0.6	0.45	0.63	230	1	2.8
DMI 2-50	0.78	0.57	0.8	230	1	3.8
DMI 2-60	0.9	0.66	0.94	230	1	4.2

DMI 2 SERIES

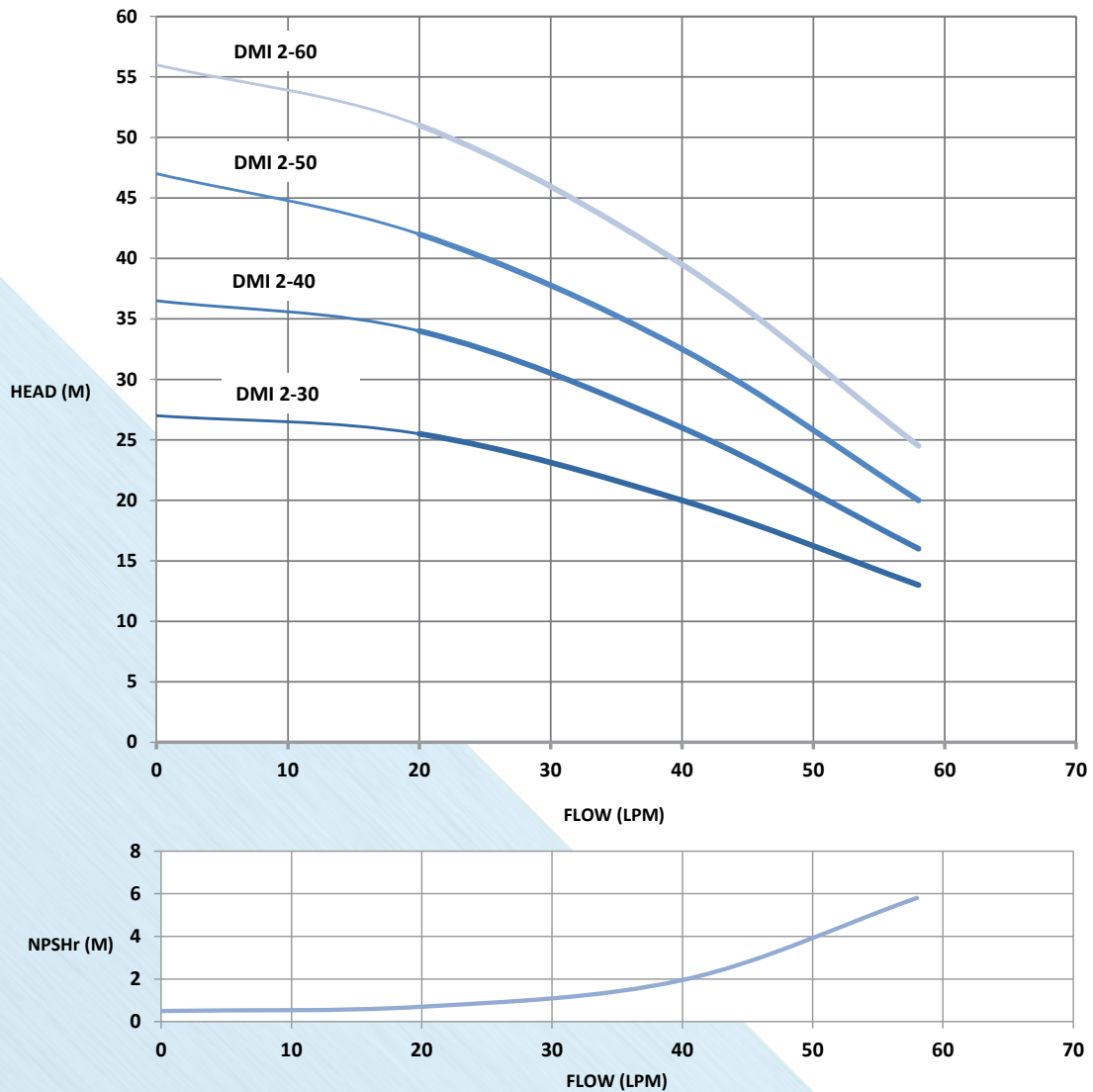

TECHNICAL DATA

DAVIES DMI 4 SERIES						
Model	Hp	Kw (P2)	Kw (P1)	Volts	Phase	Amps
DMI 4-20	0.33	0.25	0.56	230	1	2.5
DMI 4-30	0.75	0.56	0.76	230	1	3.5
DMI 4-40	1.0	0.74	1.0	230	1	4.8
DMI 4-50	1.3	0.94	1.22	230	1	5.7
DMI 4-60	1.48	1.08	1.4	230	1	6.4

DMI 4 SERIES

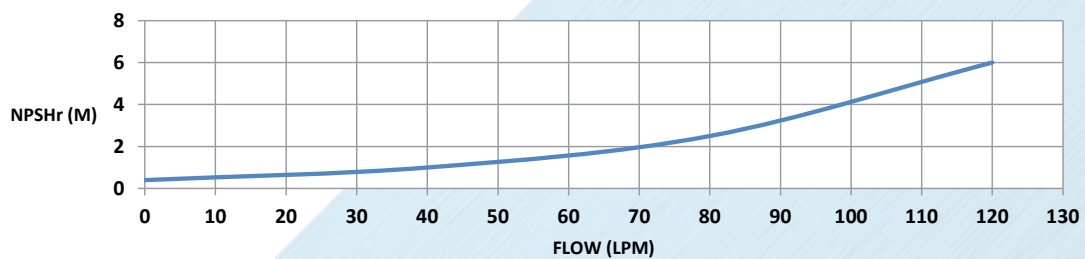
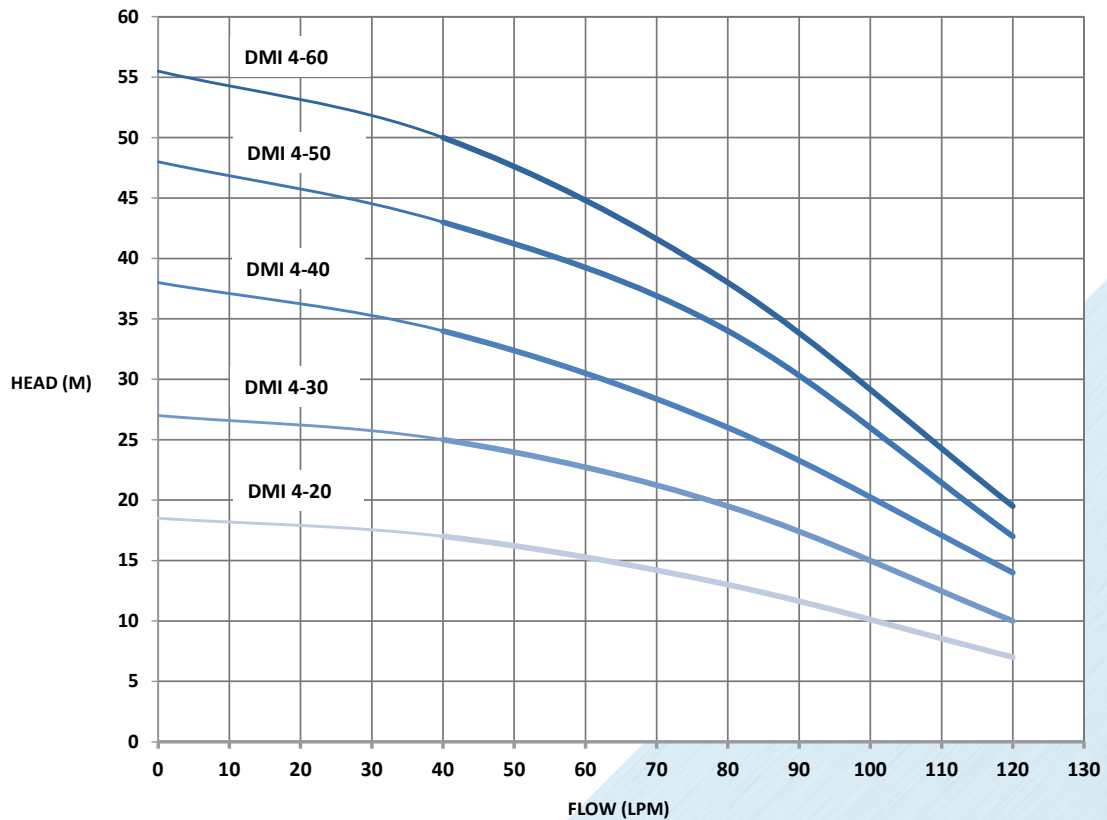

TECHNICAL DATA

DAVIES DMI 8 SERIES						
Model	Hp	Kw (P2)	Kw (P1)	Volts	Phase	Amps
DMI 8-10	0.7	0.5	0.72	230	1	2.5
DMI 8-15	1.1	0.8	1.15	230	1	3.5
DMI 8-20	1.4	1	1.4	230	1	4.8
DMI 8-25	1.8	1.3	1.9	230	1	5.7
DMI 8-30	2.2	1.6	2.1	230	1	6.4

DMI 8 SERIES

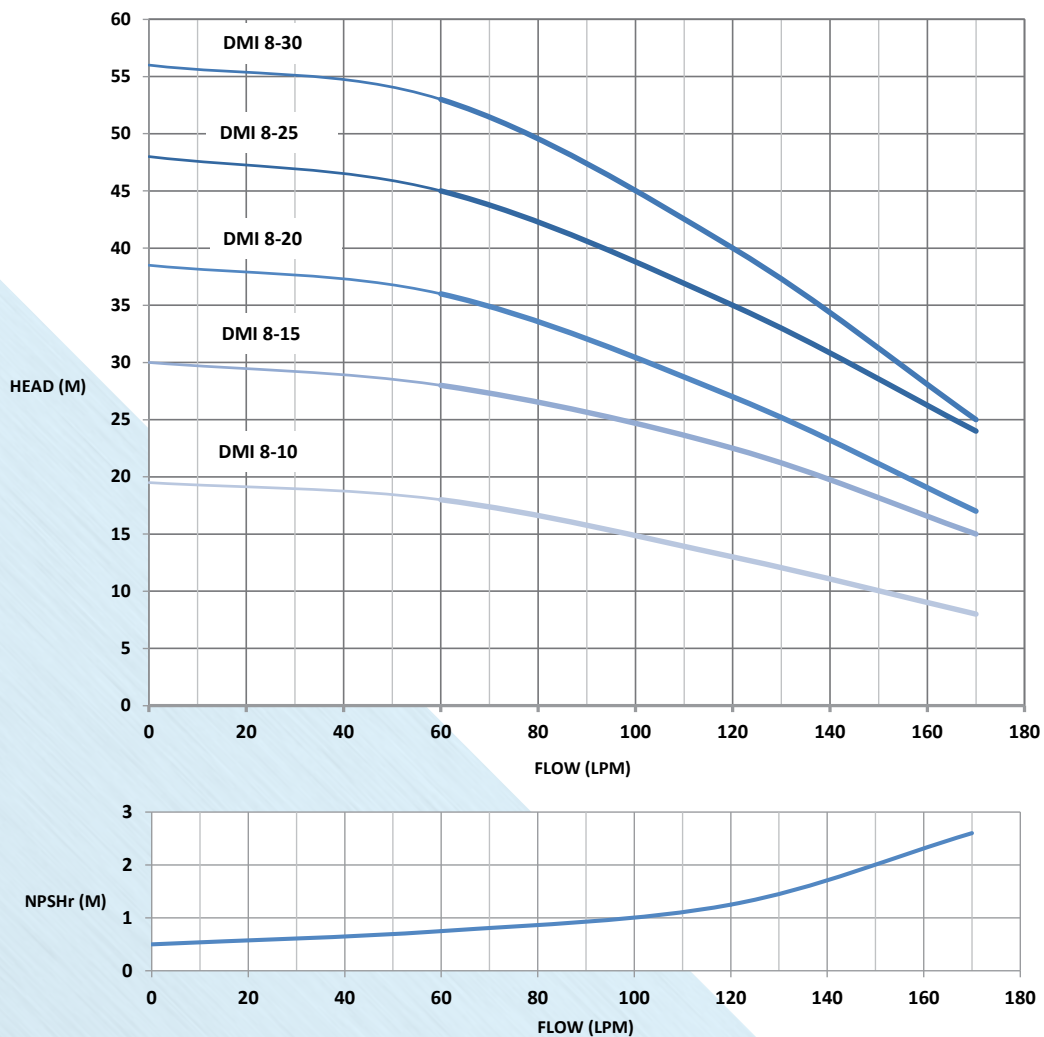

TECHNICAL DATA

DAVIES DMI 12 SERIES						
Model	Hp	Kw (P2)	Kw (P1)	Volts	Phase	Amps
DMI 12-10	1.1	0.8	1.2	230	1	5.5
DMI 12-15	1.6	1.17	1.7	230	1	7.8
DMI 12-15T	1.6	1.17	1.7	230/400	3	5.9/3.4
DMI 12-20	2.4	1.76	2.5	230	1	11.0
DMI 12-20T	2.4	1.76	2.5	230/400	3	7.4/4.3
DMI 12-25	3.0	2.17	2.9	230	1	13
DMI 12-25T	3.0	2.17	2.9	230/400	3	9.2/5.3
DMI 12-30T	3.7	2.67	3.6	230/400	3	11.6/6.7

DMI 12 SERIES

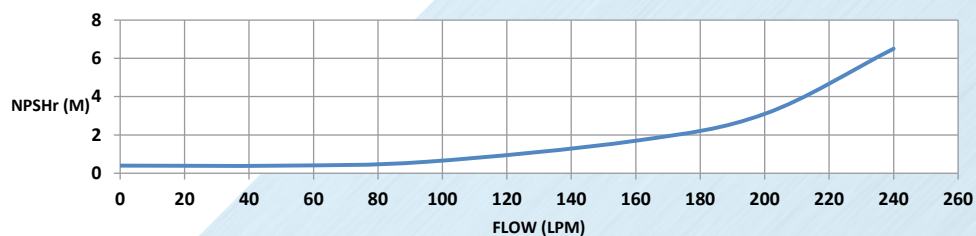
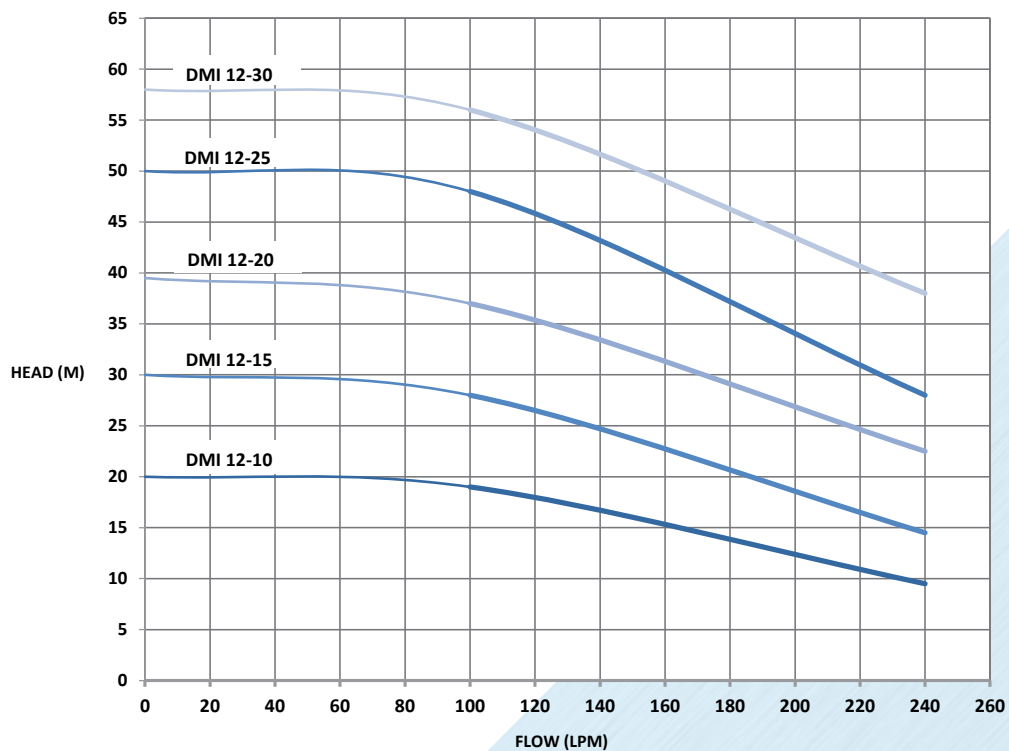

DIMENSIONS & WEIGHTS

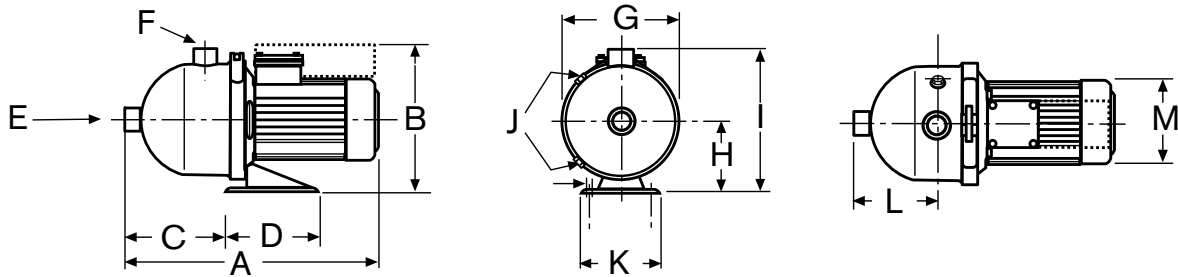

Pump model	A	B*	C	D	€	F	G	H	I	J	K	L	M	KG
DMI 2-20	403	255	171	162	1"	1"	204	118	243	3/8"	132	140	141	9.6
DMI 2-30	403	255	171	162	1"	1"	204	118	243	3/8"	132	140	141	9.9
DMI 2-40	403	255	171	162	1"	1"	204	118	243	3/8"	132	140	141	10.1
DMI 2-50	403	255	171	162	1"	1"	204	118	243	3/8"	132	140	141	10.8
DMI 2-60	403	255	171	162	1"	1"	204	118	243	3/8"	132	140	141	11.0
DMI 4-20	403	255	171	162	1 1/4"	1 1/4"	204	118	243	3/8"	132	140	141	9.6
DMI 4-30	403	255	171	162	1 1/4"	1 1/4"	204	118	243	3/8"	132	140	141	9.9
DMI 4-40	403	255	171	162	1 1/4"	1 1/4"	204	118	243	3/8"	132	140	141	10.6
DMI 4-50	441	255	171	162	1 1/4"	1 1/4"	204	118	243	3/8"	132	140	141	12.1
DMI 4-60	441	255	171	162	1 1/4"	1 1/4"	204	118	243	3/8"	132	140	141	12.3

Pump model	A	B	C	D	€	F	G	H	I	J	K	L	M	KG
220-DMI 8-10	403	255	181	162	1 1/2"	1 1/2"	204	118	243	3/8"	132	142	141	10.2
220-DMI 8-15	441	255	181	162	1 1/2"	1 1/2"	204	118	243	3/8"	132	142	141	12.2
220-DMI 8-20	441	255	181	162	1 1/2"	1 1/2"	204	118	243	3/8"	132	142	141	13.5
220-DMI 8-25	514	267	200	235	1 1/2"	1 1/2"	204	121	245	3/8"	178	142	177	23
220-DMI 8-25T	441	233	181	162	1 1/2"	1 1/2"	204	118	243	3/8"	132	142	141	14
220-DMI 8-30	514	267	200	235	1 1/2"	1 1/2"	204	121	243	3/8"	178	142	177	23
220-DMI 8-30T	493	261	200	235	1 1/2"	1 1/2"	204	121	243	3/8"	132	142	141	22
220-DMI 12-10	441	255	181	162	1 1/2"	1 1/2"	204	118	243	3/8"	132	142	141	11.5
220-DMI 12-15	441	255	181	162	1 1/2"	1 1/2"	204	118	243	3/8"	132	142	141	13.3
220-DMI 12-15T	441	233	181	162	1 1/2"	1 1/2"	204	118	243	3/8"	132	142	141	13.2
220-DMI 12-20	514	267	200	235	1 1/2"	1 1/2"	204	121	243	3/8"	178	142	141	22.5
220-DMI 12-20T	493	261	200	235	1 1/2"	1 1/2"	204	121	243	3/8"	178	142	177	21.5
220-DMI 12-25	514	267	200	235	1 1/2"	1 1/2"	204	121	243	3/8"	178	142	177	25.7
220-DMI 12-25T	493	261	200	235	1 1/2"	1 1/2"	204	121	243	3/8"	178	142	177	24.3
220-DMI 12-30T	539	284	230	245	1 1/2"	1 1/2"	204	133	259	3/8"	198	142	197	30

For your nearest dealer please contact Argon Distributors: 0508 634 341

While every endeavor has been made to publish the correct details, no responsibility will be taken for errors, omissions or changes in product specifications. Davies pumps and the 'dp' logo are registered trademarks of Argon Distributors.